

LEIF MEJLBRO

GLOBAL ANALYSIS

FUNCTIONAL ANALYSIS EXAMPLES C-1

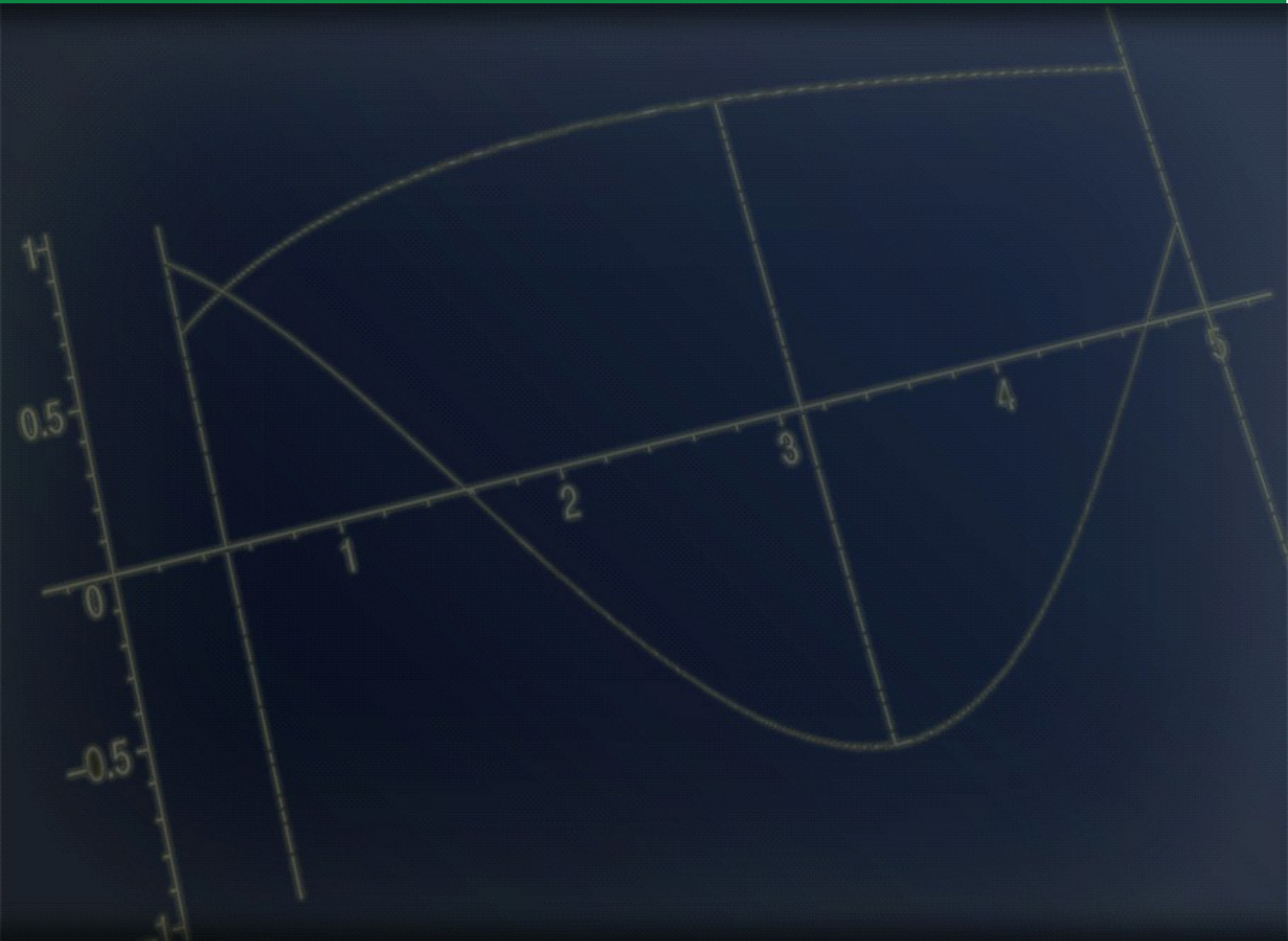

DOWNLOAD FREE TEXTBOOKS AT
BOOKBOON.COM

Leif Mejlbro

Global Analysis

Global Analysis

© 2009 Leif Mejlbro & Ventus Publishing ApS

ISBN 978-87-7681-533-2

Disclaimer: The texts of the advertisements are the sole responsibility of Ventus Publishing, no endorsement of them by the author is either stated or implied.

Contents

	Introduction	5
1	Metric Spaces	7
2	Topology 1	13
3	Continuous mappings	21
4	Topology 2	28
5	Sequences	34
6	Semi-continuity	41
7	Connected sets, differentiation a.o.	48
8	Addition and multiplication by scalars in normed vector spaces	53
9	Normed vector spaces and integral operators	57
10	Differentiable mappings	63
11	Complete metric spaces	67
12	Local Existence and Uniqueness Theorem for Autonomous Ordinary Differential Equations	71
13	Euler-Lagrange's equations	75

Introduction

This is the first book containing examples from *Functional Analysis*. We shall here deal with the subject *Global Analysis*. The contents of the following books are

Functional Analysis, Examples c-2

Topological and Metric Spaces, Banach Spaces and Bounded Operators

1. **Topological and Metric Spaces**
 - (a) Weierstraß's approximation theorem
 - (b) Topological and Metric Spaces
 - (c) Contractions
 - (d) Simple Integral Equations
2. **Banach Spaces**
 - (a) Simple vector spaces
 - (b) Normed Spaces
 - (c) Banach Spaces
 - (d) The Lebesgue integral
3. **Bounded operators**

Functional Analysis, Examples c-3

Hilbert Spaces and Operators on Hilbert Spaces

1. **Hilbert Spaces**
 - (a) Inner product spaces
 - (b) Hilbert spaces
 - (c) Fourier series
 - (d) Construction of Hilbert spaces
 - (e) Orthogonal projections and complement
 - (f) Weak convergency
2. **Operators on Hilbert Spaces**
 - (a) Operators on Hilbert spaces, general
 - (b) Closed operators

Functional Analysis, Examples c-4

Spectral theory

1. **Spectrum and resolvent**
2. **The adjoint of a bounded operator**
3. **Self-adjoint operators**
4. **Isometric operators**
5. **Unitary and normal operators**
6. **Positive operators and projections**
7. **Compact operators**

Functional Analysis, Examples c-5

Integral operators

1. Hilbert-Schmidt operators
2. Other types of integral operators

Please click the advert

WHAT'S MISSING IN THIS EQUATION?

You could be one of our future talents

MAERSK INTERNATIONAL TECHNOLOGY & SCIENCE PROGRAMME

Are you about to graduate as an **engineer** or **geoscientist**? Or have you already graduated?
If so, there may be an exciting future for you with A.P. Moller - Maersk.



MAERSK

www.maersk.com/mitas

1 Metric Spaces

Example 1.1 Let (X, d_X) and (Y, d_Y) be metric spaces. Define

$$d_{X \times Y} : (X \times Y) \times (X \times Y) \rightarrow \mathbb{R}_0^+$$

by

$$d_{X \times Y}((x_1, y_1), (x_2, y_2)) = \max(d_X(x_1, x_2), d_Y(y_1, y_2)).$$

1. Show that $d_{X \times Y}$ is a metric on $X \times Y$.

2. Show that the projections

$$p_X : X \times Y \rightarrow X, \quad p_X(x, y) = x,$$

$$p_Y : X \times Y \rightarrow Y, \quad p_Y(x, y) = y,$$

are continuous mappings.

The geometric interpretation is that $d_{X \times Y}$ compares the distances of the coordinates and then chooses the largest of them.

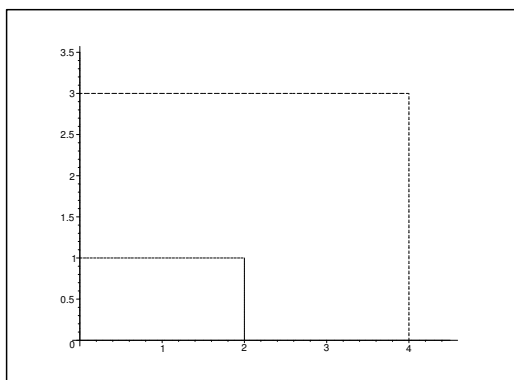

Figure 1: The points (x_1, y_1) and (x_2, y_2) , and their projections onto the two coordinate axes.

1. **MET 1.** We have assumed that d_X and d_Y are metrics, hence

$$d_{X \times Y}((x_1, y_1), (x_2, y_2)) = \max(d_X(x_1, x_2), d_Y(y_1, y_2)) \geq \max(0, 0) = 0.$$

If

$$d_{X \times Y}((x_1, y_1), (x_2, y_2)) = \max(d_X(x_1, x_2), d_Y(y_1, y_2)) = 0,$$

then

$$d_X(x_1, x_2) = 0 \quad \text{and} \quad d_Y(y_1, y_2) = 0.$$

Using that d_X and d_Y are metrics, this implies by **MET 1** for d_X and d_Y that $x_1 = x_2$ and $y_1 = y_2$, thus

$$(x_1, y_1) = (x_2, y_2),$$

and **MET 1** is proved for $d_{X \times Y}$.

MET 2. From d_X and d_Y being symmetric it follows that

$$\begin{aligned} d_{X \times Y}((x_1, y_1), (x_2, y_2)) &= \max(d_X(x_1, x_2), d_Y(y_1, y_2)) \\ &= \max(d_X(x_2, x_1), d_Y(y_2, y_1)) \\ &= d_{X \times Y}((x_2, y_2), (x_1, y_1)), \end{aligned}$$

and we have proved **MET 2** for $d_{X \times Y}$.

MET 3. THE TRIANGLE INEQUALITY. If we put in (x, y) , we get

$$\begin{aligned} d_X(x_1, x_2) &\leq d_X(x_1, x) + d_X(x, x_2) \\ &\leq d_{X \times Y}((x_1, y_1), (x, y)) + d_{X \times Y}((x, y), (x_2, y_2)), \end{aligned}$$

and analogously,

$$d_Y(y_1, y_2) \leq d_{X \times Y}((x_1, y_1), (x, y)) + d_{X \times Y}((x, y), (x_2, y_2)).$$

Hence the largest of the numbers

$$d_X(x_1, x_2) \quad \text{and} \quad d_Y(y_1, y_2)$$

must be smaller than or equal to the common right hand side, thus

$$\begin{aligned} d_{X \times Y}((x_1, y_1), (x_2, y_2)) &= \max(d_X(x_1, x_2), d_Y(y_1, y_2)) \\ &\leq d_{X \times Y}((x_1, y_1), (x, y)) + d_{X \times Y}((x, y), (x_2, y_2)), \end{aligned}$$

and **MET 3** is proved.

Summing up, we have proved that $d_{X \times Y}$ is a metric on $X \times Y$.

2. Since $p_X : X \times Y \rightarrow X$ fulfils

$$d_X(p_X((x, y)), p_X((x_0, y_0))) = d_X(x, x_0) \leq d_{X \times Y}((x, y), (x_0, y_0)),$$

we can to every $\varepsilon > 0$ choose $\delta = \varepsilon$. Then it follows from $d_{X \times Y}((x, y), (x_0, y_0)) < \varepsilon$ that

$$d_X(p_X((x, y)), p_X((x_0, y_0))) \leq d_{X \times Y}((x, y), (x_0, y_0)) < \varepsilon,$$

and we have proved that p_X is continuous.

The proof of $p_Y : X \times Y \rightarrow Y$ also being continuous, is analogous.

Example 1.2 Let (S, d) be a metric space. For every pair of points $x, y \in S$, we set

$$\bar{d}(x, y) = \frac{d(x, y)}{1 + d(x, y)}.$$

Show that \bar{d} is a metric on S with the property

$$0 \leq \bar{d}(x, y) < 1 \quad \text{for all } x, y \in S.$$

HINT: You may in suitable way use that the function $\varphi : \mathbb{R}_0^+ \rightarrow \mathbb{R}_0^+$ defined by

$$\varphi(t) = \frac{t}{1+t}, \quad t \in \mathbb{R}_0^+,$$

is increasing.

MET 1. Obviously,

$$\bar{d}(x, y) = \frac{d(x, y)}{1 + d(x, y)} \geq 0,$$

and if $\bar{d}(x, y) = 0$, then $d(x, y) = 0$, hence $x = y$.

MET 2. From $d(x, y) = d(y, x)$ follows that

$$\bar{d}(x, y) = \frac{d(x, y)}{1 + d(x, y)} = \frac{d(y, x)}{1 + d(y, x)} = \bar{d}(y, x).$$

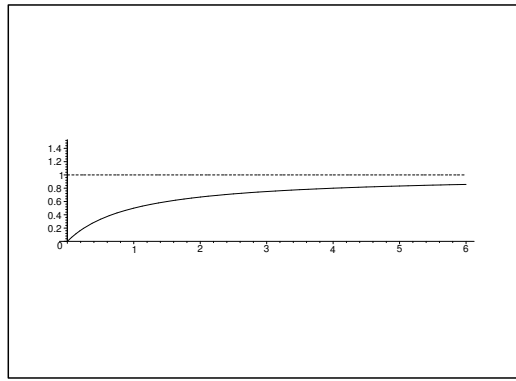
Figure 2: The graph of $\varphi(t)$ and its horizontal asymptote.

MET 3. We shall now turn to the triangle inequality,

$$\bar{d}(x, y) \leq \bar{d}(x, z) + \bar{d}(z, x).$$

Now,

$$d(x, y) \leq d(x, z) + d(z, y),$$

and

$$\varphi(t) = \frac{t}{1+t} = 1 - \frac{1}{1+t} \in [0, 1[\quad \text{for } t \geq 0,$$

is increasing. Since a positive fraction is increased, if its positive denominator is decreased (though still positive), it follows that

$$\begin{aligned} \bar{d}(x, y) &= \frac{d(x, y)}{1 + d(x, y)} = \varphi(d(x, y)) \\ &\leq \varphi(d(x, z) + d(z, x)) = \frac{d(x, z) + d(z, y)}{1 + d(x, z) + d(z, y)} \\ &= \frac{d(x, z)}{1 + d(x, z) + d(z, y)} + \frac{d(z, y)}{1 + d(x, z) + d(z, y)} \\ &= \frac{d(x, z)}{1 + d(x, z)} + \frac{d(z, y)}{1 + d(z, y)} \\ &= \bar{d}(x, z) + \bar{d}(z, y), \end{aligned}$$

and we have proved that \bar{d} is a metric.

Now, $\varphi(t) \in [0, 1]$ for $t \in \mathbb{R}_0^+$, thus

$$\bar{d}(x, y) = \varphi(d(x, y)) \in [0, 1[\quad \text{for all } x, y \in S,$$

hence

$$0 \leq \bar{d}(x, y) < 1 \quad \text{for all } x, y \in S.$$

Remark 1.1 Let $\varphi : \mathbb{R}_0^+ \rightarrow \mathbb{R}_0^+$ satisfy the following three conditions:

1. $\varphi(0) = 0$, and $\varphi(t) > 0$ for $t > 0$,
2. φ is increasing
3. $0 \leq \varphi(t + u) \leq \varphi(t) + \varphi(u)$ for all $t, u \in \mathbb{R}_0^+$.

If d is a metric on S , then $\varphi \circ d$ is also a metric on S .

The proof which follows the above, is left to the reader. \diamond

Example 1.3 Let K be an arbitrary set, and let (S, d) be a metric space, in which $0 \leq d(x, y) \leq 1$ for all $x, y \in S$.

Let $F(K, S)$ denote the set of mappings $f : K \rightarrow S$.

Define $D : F(K, S) \times F(K, S) \rightarrow \mathbb{R}_0^+$ by

$$D(f, g) = \sup_{t \in K} d(f(t), g(t)).$$

1. Show that D is a metric on $F(K, S)$.

2. Let $t_0 \in K$ be a fixed point in K and define

$$Ev_{t_0} : F(K, S) \rightarrow S \quad \text{by} \quad Ev_{t_0}(f) = f(t_0).$$

Show that Ev_{t_0} is continuous.

(Ev_{t_0} is called an evolution map.)

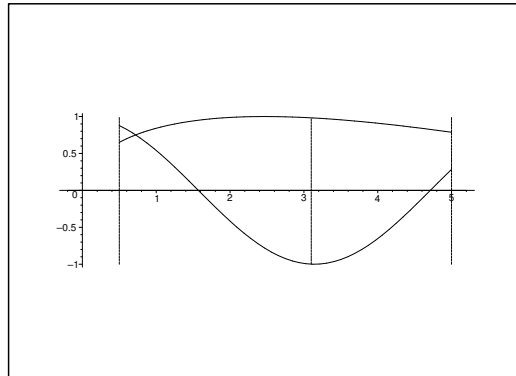

Figure 3: The metric D measures the largest point-wise distance d between the graphs of two functions over each point in the domain $t \in K$.

First notice that since $0 \leq d(x, y) \leq 1$, we have

$$D(f, g) = \sup_{t \in K} d(f(t), g(t)) \leq 1 \quad \text{for all } f, g \in F(K, S).$$

Without a condition of boundedness the supremum could give us $+\infty$, and D would *not* be defined on all of $F(K, S) \times F(K, S)$.

1. **MET 1.** Clearly, $D(f, g) \geq 0$. Assume now that

$$D(f, g) = \sup_{t \in K} d(f(t), g(t)) = 0.$$

Then

$$d(f(t), g(t)) = 0 \quad \text{for all } t \in K,$$

thus $f(t) = g(t)$ for all $t \in K$. This means that $f = g$, and **MET 1** is proved.

MET 2. is obvious, because

$$D(f, g) = \sup_{t \in K} d(f(t), g(t)) = \sup_{t \in K} d(g(t), f(t)) = D(g, f).$$

MET 3. It follows from

$$d(f(t), g(t)) \leq d(f(t), h(t)) + d(h(t), g(t)) \quad \text{for all } t \in K,$$

that

$$D(f, g) = \sup_{t \in K} d(f(t), g(t)) \leq \sup_{t \in K} \{d(f(t), h(t)) + d(h(t), g(t))\}.$$

The maximum/supremum of a sum is of course at most equal to the sum of each of the maxima/suprema, so we continue the estimate by

$$D(f, g) \leq \sup_{t \in K} d(f(t), h(t)) + \sup_{t \in K} d(h(t), g(t)) = D(f, h) + D(g, h),$$

and **MET 3** is proved.

Summing up, we have proved that D is a metric on $F(K, S)$.

2. Since

$$d(Ev_{t_0}(f), Ev_{t_0}(g)) = d(f(t_0), g(t_0)) \leq \sup_{t \in K} d(f(t), g(t)) = D(f, g),$$

we can to every $\varepsilon > 0$ choose $\delta = \varepsilon$, such that if

$$D(f, g) < \delta = \varepsilon,$$

then

$$d(Ev_{t_0}(f), Ev_{t_0}(g)) \leq D(f, g) < \varepsilon,$$

and the map $Ev_{t_0} : F(K, S) \rightarrow D$ is continuous.

Please click the advert

CHALLENGE YOURSELF

WWW.STUDYINSWEDEN.SE

Today's job market values ambitious, innovative, perceptive team players. Swedish universities foster these qualities through a forward-thinking culture where you're close to the latest ideas and global trends.

Si.
Swedish Institute

Whatever your career goals may be, studying in Sweden will give you valuable skills and a competitive advantage for your future. www.studyinsweden.se

Example 1.4 *Example 1.1 (2) and Example 1.3 (2) are both special cases of a general result. Try to formulate such a general result.*

Let (X, d_X) and (T, d_Y) be two metric spaces, and let $\varphi : \mathbb{R}_0^+ \rightarrow \mathbb{R}_0^+$ be a continuous and strictly increasing map (at least in a non-empty interval of the form $[0, a]$ with $\varphi(0) = 0$). Then the inverse map $\varphi^{-1} : [0, \varphi(a)] \rightarrow [0, a]$ exists, and is continuous and strictly increasing with $\varphi^{-1}(0) = 0$.

Theorem 1.1 *Let $f : X \rightarrow Y$ be a map. If*

$$d_Y(f(x), f(y)) \leq \varphi(d_X(x, y)) \quad \text{for all } x, y \in X,$$

then f is continuous.

PROOF. We may without loss of generality assume that $0 < \varepsilon < a$. Choose $\delta = \varphi^{-1}(\varepsilon)$. If $x, y \in X$ satisfy

$$d_X(x, y) < \delta = \varphi^{-1}(\varepsilon),$$

then we have for the image points that

$$d_Y(f(x), f(y)) \leq \varphi(d_X(x, y)) < \varphi(\varphi^{-1}(\varepsilon)) = \varepsilon,$$

and it follows that f is continuous.

EXAMPLES.

1. In the previous two examples, $\varphi(t) = t$, $t \in \mathbb{R}_0^+$. Clearly, φ is continuous and strictly increasing, and $\varphi(0) = 0$.
2. Another example is given by $\varphi(t) = c \cdot t$, $t \in \mathbb{R}_0^+$, where $c > 0$ is a constant.
3. Of more sophisticated examples we choose

$$\varphi(t) = \sqrt{t}, \quad \varphi(t) = \exp(t) - 1, \quad \varphi(t) = \ln(t + 1),$$

$$\varphi(t) = \sinh(t), \quad \varphi(t) = \tanh t, \quad \varphi(t) = \text{Arctan } t,$$

etc. etc..

2 Topology 1

Example 2.1 Let (S, d) be a metric space. For $x \in S$ and $r \in \mathbb{R}^+$ let $B_r(x)$ denote the open ball in S with centre x and radius r . Show that the system of open balls in S has the following properties:

1. If $y \in B_r(x)$ then $x \in B_r(y)$.
2. If $y \in B_r(x)$ and $0 < s \leq r - d(x, y)$, then $B_s(y) \subseteq B_r(x)$.
3. If $d(x, y) \geq r + s$, where $x, y \in S$, and $r, s \in \mathbb{R}^+$, then $B_r(x)$ and $B_s(y)$ are mutually disjoint.

We define as usual

$$B_r(x) = \{y \in S \mid d(x, y) < r\}.$$

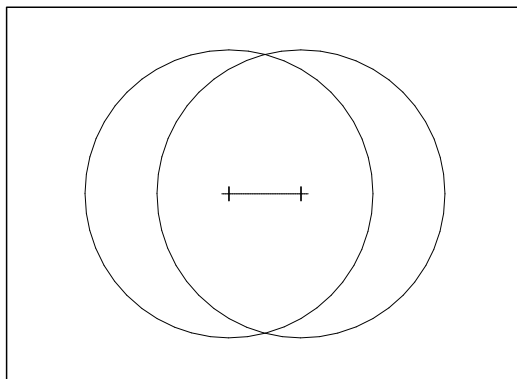

Figure 4: The two balls $B_r(x)$ and $B_r(y)$ and the line between the centres x and y . Notice that this line lies in both balls.

1. If $y \in B_r(x)$, then it follows from the above that $d(x, y) < r$. Then also $d(y, x) < r$, which we interpret as $x \in B_r(y)$.

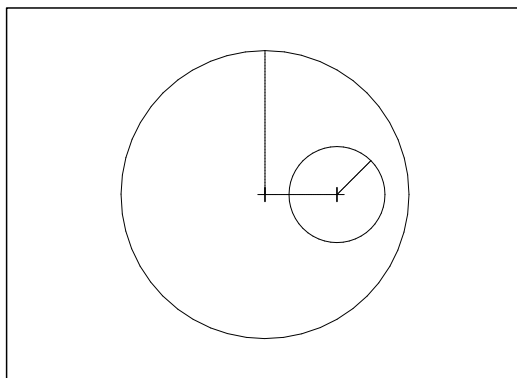

Figure 5: The larger ball $B_r(x)$ contains the smaller ball $B_s(y)$, if only $0 < s \leq r - d(x, y)$.

2. If $z \in B_s(y)$, then it follows from the triangle inequality that

$$d(x, z) \leq d(x, y) + d(y, z) < d(x, y) + s \leq d(x, y) + \{r - d(x, y)\} = r,$$

which shows that $z \in B_r(x)$. This is true for every $z \in B_s(y)$, hence

$$B_s(y) \subseteq B_r(x).$$

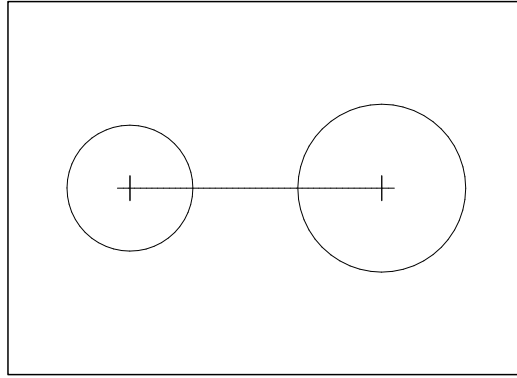

Figure 6: Two balls of radii r and s resp., where $d(x, y) \geq r + s$.

3. *Indirect proof.* Assume that the two balls are *not* disjoint. Then there exists a $z \in B_r(x) \cap B_s(y)$. We infer from the assumption $d(x, y) \geq r + s$ and the triangle inequality that

$$r + s \leq d(x, y) \leq d(x, z) + d(z, y) < r + s,$$

thus $r + r < r + s$, which is a *contradiction*. Hence our *assumption* is false, and we conclude that $B_r(x)$, and $B_s(y)$ are disjoint.

Please click the advert

www.job.oticon.dk

oticon
PEOPLE FIRST

Example 2.2 Let (S, d) be a metric space. A subset K in S is called bounded in (S, d) , if there exists a point $x \in S$ and an $r \in \mathbb{R}^+$ such that $K \subseteq B_r(x)$.

Examine the truth of each of the following three statements:

1. If two subsets K_1 and K_2 in S are bounded in (S, d) , then their union $K_1 \cup K_2$ is also bounded in (S, d) .

2. If $K \subseteq S$ is bounded in (S, d) then

$$K' = \bigcup_{x \in K} \{y \in S \mid d(x, y) \leq 1\}$$

is also bounded in (S, d) .

3. If $K \subseteq S$ is bounded in (S, d) then

$$K'' = \bigcap_{x \in K} \{y \in S \mid d(x, y) > 1\}$$

is also bounded in (S, d) .

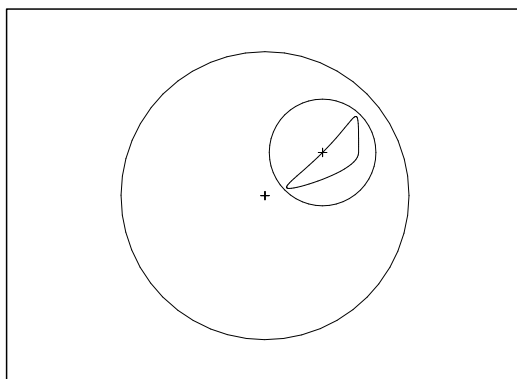

Figure 7: The smaller disc is caught by the larger disc of centre x_0 , if only its radius is sufficiently large.

Here there are several possibilities of solution. The elegant solution applies that a set K is bounded, if there exists an $R \in \mathbb{R}^+$, such that $K \subseteq B_R(x_0)$, where $x_0 \in S$ is a fixed point, which can be used for *every* bounded subset. In fact, if $K \subseteq B_r(x)$, then $d(y, x) < r$ for all $y \in K$. Then by the triangle inequality

$$d(y, x_0) \leq d(y, x) + d(x, x_0) < d(x, x_0) + r = R(x),$$

thus $K \subseteq B_R(x_0) = B_{R(x)}(x_0)$.

1. **First solution.** If K_1 and K_2 are bounded subsets, then we get with the *same* reference point $x_0 \in S$,

$$K_1 \subseteq B_{R_1}(x_0) \quad \text{and} \quad K_2 \subseteq B_{R_2}(x_0),$$

hence

$$K_1 \cup K_2 \subseteq B_{R_1}(x_0) \cup B_{R_2}(x_0) = B_{\max\{R_1, R_2\}}(x_0) = B_R(x_0).$$

Now $R = \max\{R_1, R_2\} < +\infty$, so it follows that the union $K_1 \cup K_2$ is bounded, when both K_1 and K_2 are bounded.

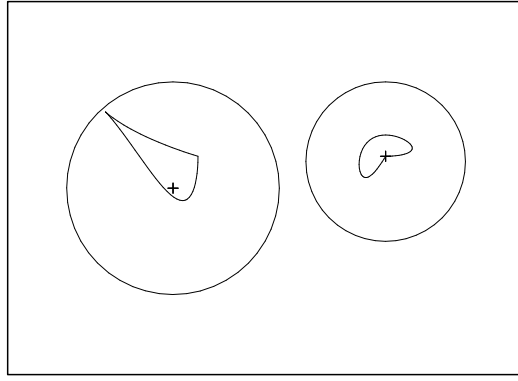

Figure 8: A graphic description of the second solution.

Second solution. Here we give a proof which is closer to the definition. First note that there are $x, y \in S$ and $r, s > 0$, such that

$$K_1 \subseteq B_r(x) \quad \text{and} \quad K_2 \subseteq B_s(y).$$

Choosing $R = r + d(x, y) + s > r$, it is obvious that since the radius is increased and the centre is the same

$$K_1 \subseteq B_r(x) \subseteq B_R(x).$$

Then apply a result from EXAMPLE 2.1 (2),

$$K_2 \subseteq B_s(y) \subseteq B_{r+d(x,y)+s}(x) = B_R(x),$$

and we see that $K_1 \cup K_2 \subseteq B_R(x) \cup B_R(x) = B_R(x)$ is bounded.

ALTERNATIVELY, it follows for every $z \in B_s(y)$ that

$$d(x, z) \leq d(x, y) + d(y, z) < d(x, y) + s < R,$$

så $K_2 \subseteq B_s(y) \subseteq B_R(x)$.

2. Now K is bounded, so $K \subseteq B_R(x_0)$, and

$$K' \subseteq B_{R+1}(x_0).$$

In fact, if $y \in K'$, then we can find an $x \in K$, such that $d(x, y) \leq 1$. Since $x \in K \subseteq B_R(x_0)$, we have $d(x, x_0) < R$. Thus

$$d(y, x_0) \leq d(y, x) + d(x, x_0) < R + 1,$$

and therefore $y \in B_{R+1}(x_0)$. This holds for every $y \in K'$, so $K' \subseteq B_{R+1}(x_0)$, and K' is bounded.

3. **First possibility; the metric d is bounded.** In this case there is a constant $c > 0$, such that

$$d(x, y) \leq c < +\infty \quad \text{for all } x, y \in S.$$

In particular, S is itself bounded,

$$S = B_c(x), \quad \text{for every } x \in S.$$

Every subset of S is bounded.

Second possibility; the metric d is unbounded. In this case the claim is not true. In fact, the complementary set of K''

$$(1) \quad S \setminus K'' = \bigcup_{x \in K} \{y \in S \mid d(x, y) \leq 1\} = K'$$

is bounded according to the second question. Then $S = K' \cup K''$ is a disjoint union, and since K' is bounded, while S is unbounded, we conclude that K'' is also unbounded. (Otherwise $K' \cup K''$ would be bounded by the first question).

Remark 2.1 PROOF OF (1). If

$$y \notin K'' = \bigcap_{x \in K} \{y \in S \mid d(x, y) > 1\},$$

then there exists an $x \in K$, such that $d(x, y) \leq 1$, and \bigcap is replaced by \bigcup , and $d(x, y) > 1$ is replaced by the negation $d(x, y) \leq 1$, and (1) follows. \diamond

Please click the advert



CHALLENGE YOURSELF

WWW.STUDYINSWEDEN.SE

Today's job market values ambitious, innovative, perceptive team players. Swedish universities foster these qualities through a forward-thinking culture where you're close to the latest ideas and global trends.

Whatever your career goals may be, studying in Sweden will give you valuable skills and a competitive advantage for your future. www.studyinsweden.se

Si.
Swedish Institute

Download free books at BookBooN.com

Example 2.3 List all topologies that can be defined on a set $S = \{a, b\}$ containing only two elements a and b .

Every topology must contain at least the empty set \emptyset and the total space $S = \{a, b\}$. The only possibilities are

$$\begin{aligned}\mathcal{T}_1 &= \{\emptyset, S\}, & \mathcal{T}_2 &= \{\emptyset, \{a\}, S\}, & \mathcal{T}_3 &= \{\emptyset, \{b\}, S\}, \\ \mathcal{T}_4 &= \mathcal{D}(S) = \{\emptyset, \{a\}, \{b\}, S\},\end{aligned}$$

where $\mathcal{D}(S)$ denotes the set of all subsets of S . It is well-known that \mathcal{T}_1 and \mathcal{T}_4 are topologies, called the coarsest and the finest topology on S .

Since any union and even any intersection of sets from \mathcal{T}_2 again belong to \mathcal{T}_2 , it follows that \mathcal{T}_2 is a topology.

Analogously for \mathcal{T}_3 (exchange a by b).

The four possibilities above are therefore all possible topologies on $S = \{a, b\}$.

Example 2.4 Let \mathcal{T} be the system of subsets U in \mathbb{R} which is one of the following types:
Either

(i) U does not contain 0 ,

or

(ii) U does contain 0 , and the complementary set $\mathbb{R} \setminus U$ is finite.

1. Show that \mathcal{T} is a topology on \mathbb{R} .

2. Show that \mathbb{R} with the topology \mathcal{T} is a Hausdorff space.

(A topological space (S, \mathcal{T}) is called a Hausdorff space, if one to any pair of points $x, y \in S$, where $x \neq y$, can find a corresponding pair of disjoint open sets $U, V \in \mathcal{T}$, such that $x \in U$ and $y \in V$)

3. Prove that the topology \mathcal{T} on \mathbb{R} is not generated by a metric on \mathbb{R} , because there does not exist any countable system of open neighbourhoods of $0 \in \mathbb{R}$ in the topology \mathcal{T} with the property that any arbitrary open set of $0 \in \mathbb{R}$ contains a neighbourhood from this system.

1. We shall prove that

TOP 1. If $\{U_i \in \mathcal{T} \mid i \in I\} \subset \mathcal{T}$, then $\bigcup_{i \in I} U_i \in \mathcal{T}$.

TOP 2. If $U_i \in \mathcal{T}$, $i = 1, \dots, k$, then $\bigcap_{i=1}^k U_i \in \mathcal{T}$.

TOP 1. $\emptyset, \mathbb{R} \in \mathcal{T}$.

We go through them one by one.

TOP 1. Let $\{U_i \in \mathcal{T} \mid i \in I\}$ be any family of sets from \mathcal{T} .

(i) If no U_i , $i \in I$, contains 0 , then $0 \notin \bigcup_{i \in I} U_i$, which means that $\bigcup_{i \in I} U_i \in \mathcal{T}$.

(ii) If (at least) one U_i contains 0 , and $\mathbb{R} \setminus U_i$ is finite, then

$$0 \in \bigcup_{i \in I} U_i \quad \text{and} \quad \mathbb{R} \setminus \bigcup_{i \in I} U_i \subseteq \mathbb{R} \setminus U_i \text{ is finite.}$$

This proves that $\bigcup_{i \in I} U_i \in \mathcal{T}$.

Summing up, we have proved condition **TOP 1** for a topology.

TOP 2. Let $\{U_i \in \mathcal{T} \mid i = 1, \dots, k\}$ be a finite family of sets from \mathcal{T} . We shall start by considering a system of sets, which all satisfy (ii).

(ii) If $0 \in U_i$, and $\mathbb{R} \setminus U_i$ is finite for every $i = 1, \dots, k$, then $0 \in \bigcap_{i=1}^k U_k$, and

$$\mathbb{R} \setminus \bigcap_{i=1}^k U_i = \bigcup_{i=1}^k \mathbb{R} \setminus U_i$$

is a finite union of finite sets, hence itself finite.

ALTERNATIVELY, the *longer* version is the following: If $\mathbb{R} \setminus U_i$ contains n_i different elements, then $\bigcup_{i=1}^k \mathbb{R} \setminus U_i$ contains at most $n = \sum_{i=1}^k n_i < +\infty$ different elements.

In this case we conclude that $\bigcap_{i=1}^k U_i \in \mathcal{T}$.

(i) If there is an U_i , where $i \in \{1, \dots, k\}$, such that $0 \notin U_i$, (notice that we are not at all concerned with the other sets U_j being open of type (i) or type (ii); we shall just have one open set of type (i)), then clearly $0 \notin \bigcap_{i=1}^k U_i$, thus $\bigcap_{i=1}^k U_i \in \mathcal{T}$.

Summing up we have proved condition **TOP 2** for a topology.

TOP 3. From $0 \notin \emptyset$ follows from (i) that $\emptyset \in \mathcal{T}$. From $0 \in \mathbb{R}$ and $\mathbb{R} \setminus \mathbb{R} = \emptyset$ containing no element it follows by (ii) that $\mathbb{R} \in \mathcal{T}$, and we have proved the remaining condition **TOP 3** for a topology.

Summing up we have proved that \mathcal{T} is a topology.

Please click the advert

Turning a challenge into a learning curve. Just another day at the office for a high performer.

Accenture Boot Camp – your toughest test yet

Choose Accenture for a career where the variety of opportunities and challenges allows you to make a difference every day. A place where you can develop your potential and grow professionally, working alongside talented colleagues. The only place where you can learn from our unrivalled experience, while helping our global clients achieve high performance. If this is your idea of a typical working day, then Accenture is the place to be.

It all starts at Boot Camp. It's 48 hours that will stimulate your mind and enhance your career prospects. You'll spend time with other students, top Accenture Consultants and special guests. An inspirational two days

packed with intellectual challenges and activities designed to let you discover what it really means to be a high performer in business. We can't tell you everything about Boot Camp, but expect a fast-paced, exhilarating

and intense learning experience. It could be your toughest test yet, which is exactly what will make it your biggest opportunity.

Find out more and apply online.

Visit [accenture.com/bootcamp](https://www.accenture.com/bootcamp)

• Consulting • Technology • Outsourcing

High performance. Delivered.

2. We shall now prove that the space $(\mathbb{R}, \mathcal{T})$ is a Hausdorff space.

- (i) If $x, y \in \mathbb{R} \setminus \{0\}$, then $\{x\}, \{y\} \in \mathcal{T}$ by definition (i). Furthermore, if $x \neq y$, then clearly $\{x\} \cap \{y\} = \emptyset$.
- (ii) If $x \in \mathbb{R} \setminus \{0\}$ and $y = 0$, then $\{x\}, \mathbb{R} \setminus \{x\} \in \mathcal{T}$ by (i) and (ii), resp., and $0 \in \mathbb{R} \setminus \{x\}$, and $\{x\} \cap (\mathbb{R} \setminus \{x\}) = \emptyset$.

We have proved that the space is a Hausdorff space.

3. Assume that $\{U_n \mid n \in \mathbb{N}\}$ is a countable system of open neighbourhoods of 0, thus $0 \in U_n$, and $\mathbb{R} \setminus U_n$ is finite. Then the “exceptional set”

$$A = \bigcup_{n=1}^{\infty} \mathbb{R} \setminus U_n$$

is at most countable. In particular, $A \neq \mathbb{R}$.

Choose any point $a \in \mathbb{R} \setminus (A \cup \{0\})$. Then $U = \mathbb{R} \setminus \{a\} \in \mathcal{T}$ is a neighbourhood of 0, and none of the U_n is contained in U .

In fact, if $U_n \subseteq U$, then

$$\{a\} = \mathbb{R} \setminus U \subseteq \mathbb{R} \setminus U_n \subseteq \bigcup_{n=1}^{\infty} \mathbb{R} \setminus U_n = A,$$

which is a contradiction.

3 Continuous mappings

Example 3.1 Let S be a topological space with topology \mathcal{T} , and let $\pi : S \rightarrow \tilde{S}$ be a mapping into a set \tilde{S} . Let $\tilde{\mathcal{T}}$ be the quotient topology induced from the topology \mathcal{T} on S by the mapping π .

1. Let \mathcal{T}' be a topology on \tilde{S} , such that $\pi : S \rightarrow \tilde{S}$ is continuous when S is considered with the topology \mathcal{T} and \tilde{S} with the topology \mathcal{T}' .

Show that $\mathcal{T}' \subseteq \tilde{\mathcal{T}}$.

(The quotient topology $\tilde{\mathcal{T}}$ on \tilde{S} is in other words the ‘largest’ topology on \tilde{S} for which $\pi : S \rightarrow \tilde{S}$ is continuous.)

2. Show that when \tilde{S} has the quotient topology determined by the mapping $\pi : S \rightarrow \tilde{S}$, then the following holds:

- A mapping $f : \tilde{S} \rightarrow T$ into a topological space T is continuous if and only if the composite mapping $f \circ \pi : S \rightarrow T$ is continuous.

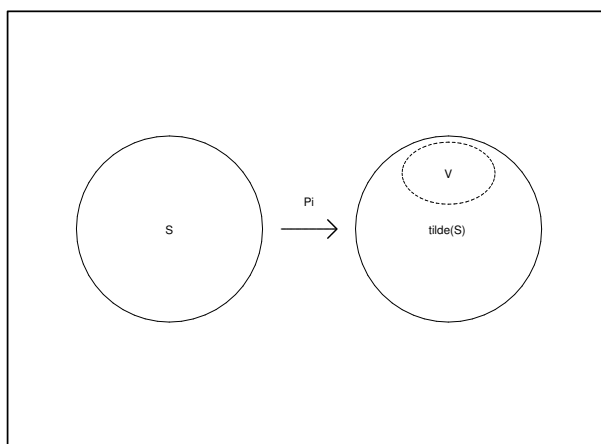

Figure 9: The topology \mathcal{T} is defined on S , and the quotient topology $\tilde{\mathcal{T}}$, or \mathcal{T}' , is defined on \tilde{S} .

We recall that the quotient topology is defined by

$$\tilde{\mathcal{T}} = \{V \subseteq \tilde{S} \mid U = \pi^{-1}(V) \in \mathcal{T}\}.$$

1. If $\pi : S \rightarrow \tilde{S}$ is continuous in the topology \mathcal{T}' on \tilde{S} and \mathcal{T} on S , then

$$\pi^{-1}(V) \in \mathcal{T} \quad \text{for every } V \in \mathcal{T}',$$

hence $V \in \tilde{\mathcal{T}}$ for every $V \in \mathcal{T}'$. This means precisely that

$$\mathcal{T}' \subseteq \tilde{\mathcal{T}}.$$

2. Assume that $f : \tilde{S} \rightarrow T$ is continuous, where \tilde{S} has the quotient topology $\tilde{\mathcal{T}}$ determined by $\pi : S \rightarrow \tilde{S}$, and where T has the topology \mathcal{T}^* . This means that

$$f^{-1}(V) \in \tilde{\mathcal{T}} = \{W \subseteq \tilde{S} \mid \pi^{-1}(W) \in \mathcal{T}\}$$

for every $V \in \mathcal{T}^*$.

Then it follows that

$$\pi^{-1}(W) = \pi^{-1}(f^{-1}(V)) = (f \circ \pi)^{-1}(V) \in \mathcal{T}$$

for every $V \in \mathcal{T}^*$. This is precisely the condition that the composite mapping $f \circ \pi : S \rightarrow T$ is continuous.

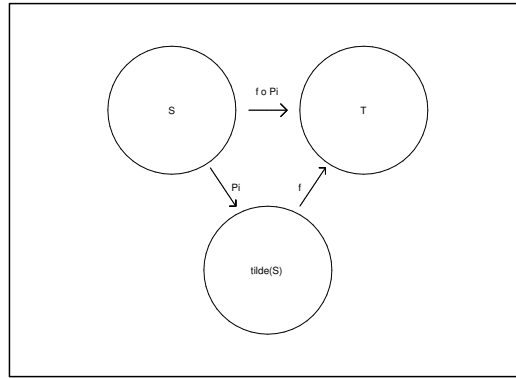

Figure 10: Diagram, where S has the topology \mathcal{T} , and \tilde{S} has the topology $\tilde{\mathcal{T}}$, and T has the topology $\cap T^*$.

Conversely, if $f \circ \pi : S \rightarrow T$ is continuous, then

$$\mathcal{T} \ni (f \circ \pi)^{-1}(V) = \pi^{-1}(f^{-1}(V)) \quad \text{for every } V \in T^*.$$

Then it follows from the definition of the quotient topology that if $\pi^{-1}(f^{-1}(V)) \in \mathcal{V}$, then $f^{-1}(V) \in \tilde{\mathcal{T}}$.

Since $f^{-1}(V) \in \tilde{\mathcal{T}}$ for every $V \in T^*$, it follows that $f : \tilde{S} \rightarrow T$ is continuous, and the claim is proved.

Please click the advert



it's an interesting world

Get under the skin of it.

Graduate opportunities
Cheltenham | £24,945 + benefits

One of the UK's intelligence services, GCHQ's role is two-fold: to gather and analyse intelligence which helps shape Britain's response to global events, and, to provide technical advice for the protection of Government communication and information systems. In doing so, our specialists – in IT, internet, engineering, languages, information assurance, mathematics and intelligence – get well beneath the surface of global affairs. If you thought the world was an interesting place, you really ought to explore our world of work.

www.careersinbritishintelligence.co.uk

Applicants must be British citizens. GCHQ values diversity and welcomes applicants from all sections of the community. We want our workforce to reflect the diversity of our work.



INVESTORS
IN PEOPLE



Example 3.2 Let S be a topological space. For every pair of real-valued functions $f, g : S \rightarrow \mathbb{R}$, we can in the usual way define the functions $f + g$, $f - g$, $f \cdot g$, and (if $g(x) \neq 0$ for all $x \in S$) f/g .

1. Show that if f and g are continuous at a point $x_0 \in S$, then also $f + g$, $f - g$, $f \cdot g$, and (when it is defined) f/g are continuous at $x_0 \in S$.

(Carry through the argument in at least one case.)

2. Assume that $f, g : S \rightarrow \mathbb{R}$ are continuous. Show that

$$U = \{x \in S \mid f(x) < g(x)\}$$

is an open set in S .

3. Let $f_1, \dots, f_k : S \rightarrow \mathbb{R}$ be continuous real-valued functions. Show that

$$U = \{x \in S \mid f_i(x) < a_i, i = 1, \dots, k\}$$

is an open set in S , where $a_1, \dots, a_k \in \mathbb{R}$ are real numbers.

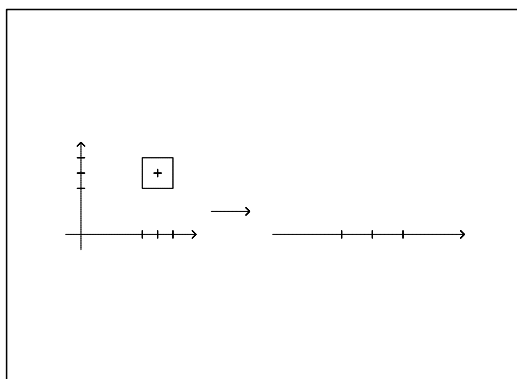

Figure 11: The interval $\left[a + \frac{\varepsilon}{2}, b + \frac{\varepsilon}{2}\right]$ to the left is by addition $+$ mapped into the interval $[a + b - \varepsilon, a + b + \varepsilon]$.

1. In reality, this example is concerned with the continuity of the basic four arithmetical operations

$$+, -, \cdot : \mathbb{R} \times \mathbb{R} \rightarrow \mathbb{R} \quad \text{og} \quad / : \mathbb{R} \times (\mathbb{R} \setminus \{0\}) \rightarrow \mathbb{R}.$$

The remaining part follows easily by composition of continuous mappings.

(a) *Addition* $+$: $\mathbb{R} \times \mathbb{R} \rightarrow \mathbb{R}$ is continuous.

Let $(a, b) \in \mathbb{R} \times \mathbb{R}$ be given. To every $\varepsilon > 0$ choose $\delta = \frac{\varepsilon}{2}$. If

$$|x - a| < \frac{\varepsilon}{2} \quad \text{and} \quad |y - b| < \frac{\varepsilon}{2},$$

then

$$|(x + y) - (a + b)| \leq |x - a| + |y - b| < \varepsilon,$$

which is precisely the classical proof of continuity.

(b) *Subtraction* $-$: $\mathbb{R} \times \mathbb{R} \rightarrow \mathbb{R}$ follows the same pattern: If

$$|x - a| < \frac{\varepsilon}{2} \quad \text{and} \quad |y - b| < \frac{\varepsilon}{2},$$

then

$$|(x - y) - (a - b)| \leq |x - a| + |y - b| < \varepsilon.$$

(c) *Multiplication* $\cdot : \mathbb{R} \times \mathbb{R} \rightarrow \mathbb{R}$ is continuous.

We first assume that $|x - a| < \delta$ and $|y - b| < \delta$ in order to derive the right relation between δ and ε . From $f(x, y) = x \cdot y$, we get by the triangle inequality by inserting $-ay + av = 0$ that

$$\begin{aligned} |f(x, y) - f(a, b)| &= |xy - an| = |xy - ay + au - ab| \\ &\leq |x - a| \cdot |y| + |a| \cdot |y - b| \leq \delta \cdot |y| + |a| \cdot \delta \\ &\leq \delta(|b| + \delta + |a|). \end{aligned}$$

Since $\varphi(\delta) = \delta(|a| + |b| + \delta)$ is continuous and strictly increasing for $\delta \in \mathbb{R}_0^+$ of the value $\varphi(0) = 0$, the mapping φ has a (continuous) inverse φ^{-1} . By choosing $\delta = \varphi^{-1}(\varepsilon)$, we get precisely

$$|f(x, y) - f(a, b)| \leq \varphi(\delta) = \varepsilon,$$

and the multiplication is continuous.

(d) The mapping $y \rightarrow \frac{1}{y}$ is continuous for $y \in \mathbb{R} \setminus \{0\}$.

Let $b \neq 0$, and choose y and $\delta \in]0, |b|$, such that

$$|y - b| < \delta < |b|.$$

Then

$$\left| \frac{1}{y} - \frac{1}{b} \right| = \frac{|y - b|}{|y| \cdot |b|} \leq \frac{\delta}{|b| \cdot (|b| - \delta)}, \quad \text{for } \delta \in]0, |b|.$$

It is obvious that to any $\varepsilon > 0$ there is a $\delta > 0$, such that

$$\left| \frac{1}{y} - \frac{1}{b} \right| \leq \frac{\delta}{|b| \cdot (|b| - \delta)} < \varepsilon,$$

and the mapping is continuous.

(e) If the denominator is $\neq 0$, then the *division* is continuous.

This is obvious, because division is composed of the continuous mappings

$$d) (x, y) \rightsquigarrow \left(x, \frac{1}{y}\right), \quad \text{and} \quad c) \left(x, \frac{1}{y}\right) \rightsquigarrow x \cdot \frac{1}{y} = \frac{x}{y},$$

thus it is itself continuous.

Summing up we have proved that if $\varphi : \mathbb{R} \times \mathbb{R} \rightarrow \mathbb{R}$ is one of the four basic arithmetical operations $+$, $-$, \cdot , $/$ (provided the denominator is $\neq 0$), then φ is continuous. Then the mapping

$$\begin{array}{ccccc} \Delta & & f \times g & & \varphi \\ S & \rightarrow & S \times S & \rightarrow & \mathbb{R} \times \mathbb{R} & \rightarrow & \mathbb{R}, \end{array}$$

is also continuous, because the diagonal mapping $\Delta(x) = (x, x)$ is trivially continuous, and because $f \times f$ is continuous at $(x_0, x_0) \in S \times S$.

We have now proved 1).

2. If $f, g : S \rightarrow \mathbb{R}$ are both continuous, then $f - g : S \rightarrow \mathbb{R}$ is also continuous according to 1).

Then

$$U = \{x \in S \mid f(x) < g(x)\} = \{x \in S \mid (f - g)(x) < 0\} = (f - g)^{\circ-1}(] - \infty, 0])$$

is open, because $\mathbb{R}^- =] - \infty, 0])$ is open.

3. Each

$$U_i = \{x \in S \mid f_i(x) < a_i\} = f_i^{\circ-1}(] - \infty, a_i])$$

is open, hence

$$U = \{x \in S \mid f_i(x) < a_i, i = 1, \dots, k\} = \bigcap_{i=1}^k \{x \in S \mid f_i(x) < a_i\} = \bigcap_{i=1}^k U_i$$

is also open as a *finite* intersection of open sets.

Example 3.3 Let S be a topological space with topology \mathcal{T} , and let A be an arbitrary subset in S . Equip A with the induced topology \mathcal{T}_A . Show that a subset $B' \subseteq A$ is closed in A with the topology \mathcal{T}_A if and only if there exists a closed subset $B \subseteq S$ in the topology \mathcal{T} such that $B' = A \cap B$.

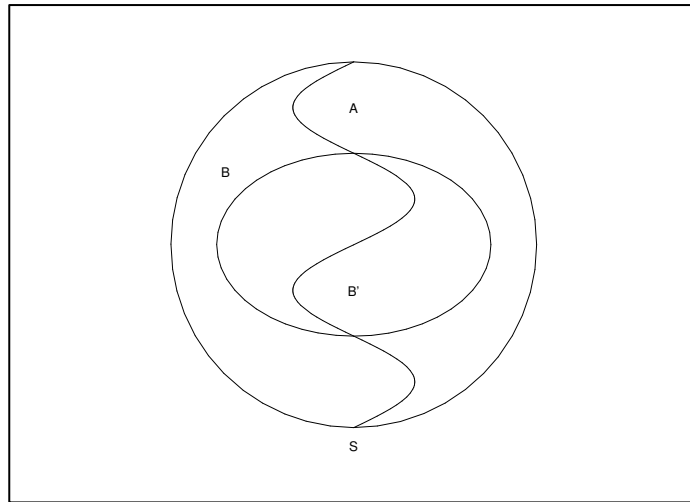

Figure 12: Diagram of the sets of Example 3.3.

The induced topology \mathcal{T}_A is defined by

$$\mathcal{T}_A = \{U \cap A \mid U \in \mathcal{T}\}.$$

1. Assume that $B' \subseteq A$ is closed in \mathcal{T}_A , thus $A \setminus B'$ is open in \mathcal{T}_A . By the above there is an $U \in \mathcal{T}$, such that

$$U \cap A = A \setminus B'.$$

Then $B = S \setminus U$ is closed, and

$$B \cap A = A \cap (S \setminus U) = A \setminus U = A \setminus (A \setminus B') = B'.$$

2. Assume conversely that $B' = A \cap B$, where B is closed in S , thus $U = S \setminus B \in \mathcal{T}$ is open. Then

$$U \cap A = A \cap (S \setminus B) = A \setminus B \in \mathcal{T}_A$$

is open in A , hence

$$A \setminus (U \cap A) = A \setminus (A \setminus B) = A \cap B = B'$$

is closed in A , i.e. in the topology \mathcal{T}_A .

Example 3.4 Let $f : X \rightarrow Y$ be a mapping between topological spaces X and Y .

If $f : X \rightarrow Y$ maps a subset $X' \subseteq X$ in X into a subset $Y' \subseteq Y$ in Y , then f determines a mapping $f' : X' \rightarrow Y'$ defined by $f'(x) = f(x)$ for $x \in X'$.

When a subset of a topological space is considered as a topological space in the following, it is always with the induced topology.

1. Let $f' : X' \rightarrow Y'$ be a mapping determined by $f : X \rightarrow Y$ as above. Show that if f is continuous, then f' is continuous.
2. Let A_1 and A_2 be closed subsets in X such that $X = A_1 \cup A_2$. Let $f_1 : A_1 \rightarrow Y$ and $f_2 : A_2 \rightarrow Y$ be the mapping determined by f , i.e. the restrictions of f to A_1 and A_2 respectively. Show that if f_1 and f_2 are continuous, then f is continuous.

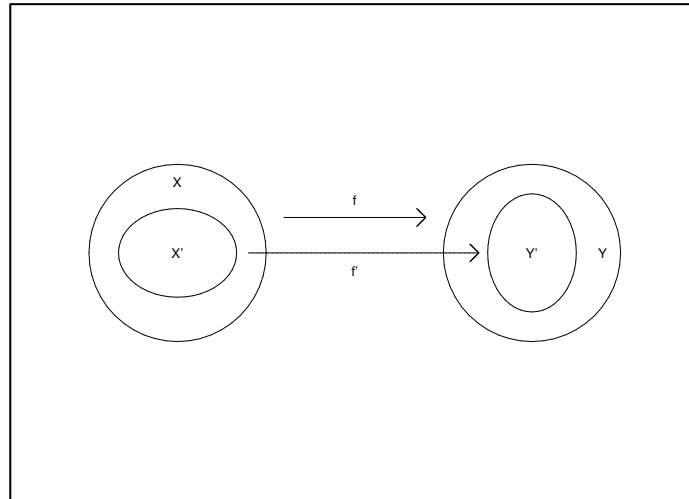

Figure 13: The restriction mapping of the first question.

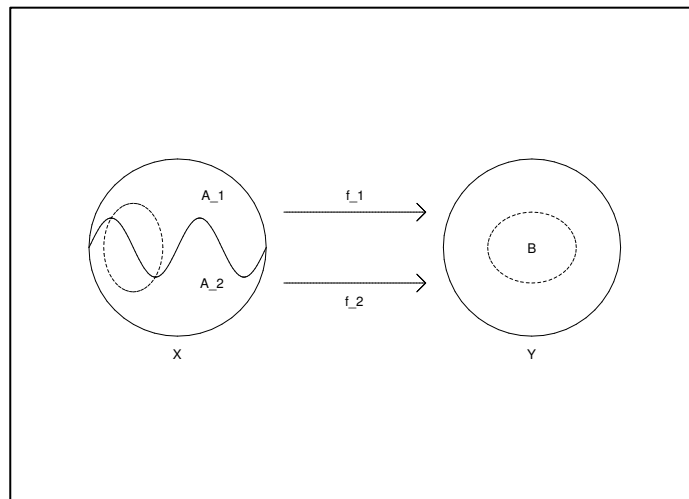

Figure 14: Diagram corresponding to the second question.

1. Let $U' \in \mathcal{T}_{Y'}$ be open in Y' , thus there is an $U \in \mathcal{T}_Y$, such that

$$U' = U \cap Y'.$$

Since f is continuous and $U \in \mathcal{T}_Y$, we have $f^{\circ-1}(U) \in \mathcal{T}_X$, hence

$$(f')^{\circ-1}(U') = (f')^{\circ-1}(U \cap Y') = f^{\circ-1}(U) \cap X' \in \mathcal{T}_{X'},$$

proving that f' is continuous.

2. Choosing $B \subseteq Y$ closed, we get

$$f^{\circ-1}(B) = f_1^{\circ-1}(B) \cup f_2^{\circ-1}(B),$$

where $f_1^{\circ-1}(B)$ is closed in A_1 , and $f_2^{\circ-1}(B)$ is closed in A_2 .

Since both A_1 and A_2 are closed, it follows that $f_1^{\circ-1}(B)$ and $f_2^{\circ-1}(B)$ are closed in S , thus $f^{\circ-1}(B)$ is closed in S , and f is continuous, where

$$f(x) = \begin{cases} f_1(x), & x \in A_1, \\ f_2(x), & x \in A_2, \end{cases} \quad A_1, A_2 \text{ are closed and disjoint.}$$

Please click the advert



Brain power

By 2020, wind could provide one-tenth of our planet's electricity needs. Already today, SKF's innovative know-how is crucial to running a large proportion of the world's wind turbines.

Up to 25 % of the generating costs relate to maintenance. These can be reduced dramatically thanks to our systems for on-line condition monitoring and automatic lubrication. We help make it more economical to create cleaner, cheaper energy out of thin air.

By sharing our experience, expertise, and creativity, industries can boost performance beyond expectations. Therefore we need the best employees who can meet this challenge!

The Power of Knowledge Engineering

Plug into The Power of Knowledge Engineering.
Visit us at www.skf.com/knowledge

SKF

4 Topology 2

Example 4.1 Let W_1 and W_2 be arbitrary subsets in the topological space S . Show that

1. $\text{int}(W_1 \cap W_2) = \text{int } W_1 \cap \text{int } W_2$.
2. $\text{int}(W_1 \cup W_2) \supseteq \text{int } W_1 \cup \text{int } W_2$.

Give an example that the equality sign in (2) does not apply in general.

1. If $x \in \text{int}(W_1 \cap W_2)$, then there is an open set U in S , such that

$$x \in U \subseteq W_1 \cap W_2,$$

and since $W_1 \cap W_2 \subseteq W_i$, $i = 1, 2$, we get in particular that

$$x \in U \subseteq W_1 \quad \text{and} \quad x \in U \subseteq W_2, \quad \text{so } x \in \text{int } W_1 \cap \text{int } W_2.$$

This shows that

$$\text{int}(W_1 \cap W_2) \subseteq \text{int } W_1 \cap \text{int } W_2.$$

Conversely, if $x \in \text{int } W_1 \cap \text{int } W_2$, then there exist open sets U_1 and U_2 , such that

$$x \in U_1 \subseteq W_1 \quad \text{and} \quad x \in U_2 \subseteq W_2.$$

Then $U = U_1 \cap U_2$ is open, and

$$x \in U = U_1 \cap U_2 \subseteq W_1 \cap W_2, \quad \text{thus } x \in \text{int}(W_1 \cap W_2).$$

It follows that $\text{int}(W_1 \cap W_2) \supseteq \text{int } W_1 \cap \text{int } W_2$, and we have proved that

$$\text{int}(W_1 \cap W_2) = \text{int } W_1 \cap \text{int } W_2.$$

2. We get from $W_1 \subseteq W_1 \cup W_2$ and $W_2 \subseteq W_1 \cup W_2$ that

$$\text{int } W_1 \subseteq \text{int}(W_1 \cup W_2) \quad \text{og} \quad \text{int } W_2 \subseteq \text{int}(W_1 \cup W_2),$$

hence by taking the union,

$$\text{int } W_1 \cup \text{int } W_2 \subseteq \text{int}(W_1 \cup W_2).$$

3. We do not always have equality here. An extreme example is

$$W_1 = \mathbb{Q} \subset \mathbb{R} \quad \text{and} \quad W_2 = \mathbb{R} \setminus \mathbb{Q} \subset \mathbb{R},$$

i.e. the rational numbers and the irrational numbers. Then $\text{int } \mathbb{Q} = \emptyset$ and $\text{int}(\mathbb{R} \setminus \mathbb{Q}) = \emptyset$, hence

$$\emptyset = \text{int}(W_1) \cup \text{int}(W_2) \subset \text{int}(\mathbb{Q} \cup (\mathbb{R} \setminus \mathbb{Q})) = \text{int}(\mathbb{R}) = \mathbb{R},$$

and we do not have equality.

Example 4.2 Show that a topological space S is a T_1 -space if and only if every subset in S containing exactly one point is a closed subset.

Recall that S is a T_1 -rum, if to any pair $x, y \in S$ of different points, $x \neq y$, there exists an open neighbourhood V of y , such that $x \notin V$.

1. Assume that all singletons $\{x\}$, $x \in S$, are closed. Then $S \setminus \{x\}$ is open.

If $x, y \in S$ and $x \neq y$, choose $U = S \setminus \{y\}$ as an open neighbourhood of x , and $V = S \setminus \{x\}$ as an open neighbourhood of y . Then clearly, $y \notin U$ and $x \notin V$, and S is a T_1 -space.

2. Conversely, assume that e.g. $\{x\}$ is *not* closed. Then the closure $\overline{\{x\}}$ contains a point $y \in \overline{\{x\}} \setminus \{x\} \neq \emptyset$, and $\overline{\{x\}}$ is the smallest closed set which contains x .

If S were a T_1 -rum, then there would be an open neighbourhood V of y , which does not contain x . Then $\overline{\{x\}} \cap (S \setminus V)$ would be closed (as an intersection of two closed sets), non-empty (because x lies in both sets), and certainly contained in $\overline{\{x\}}$, i.e.

$$\emptyset \neq \overline{\{x\}} \cap (S \setminus V) \subseteq \overline{\{x\}} \setminus \{y\} \begin{cases} \subset \overline{\{x\}}, \\ \neq \overline{\{x\}}. \end{cases}$$

This is not possible because $\overline{\{x\}}$ is defined as the smallest closed set containing $\{x\}$.

Hence, if S is a T_1 -space, then every point $\{x\}$ is closed.

Trust and responsibility

NNE and Pharmaplan have joined forces to create NNE Pharmaplan, the world's leading engineering and consultancy company focused entirely on the pharma and biotech industries.

Inés Aréizaga Esteva (Spain), 25 years old
Education: Chemical Engineer

– You have to be proactive and open-minded as a newcomer and make it clear to your colleagues what you are able to cope. The pharmaceutical field is new to me. But busy as they are, most of my colleagues find the time to teach me, and they also trust me. Even though it was a bit hard at first, I can feel over time that I am beginning to be taken seriously and that my contribution is appreciated.

Please click the advert



NNE Pharmaplan is the world's leading engineering and consultancy company focused entirely on the pharma and biotech industries. We employ more than 1500 people worldwide and offer global reach and local knowledge along with our all-encompassing list of services.
nnepharmaplan.com

nne pharmaplan®

Example 4.3 Let S be a Hausdorff space, and let W be an arbitrary subset of S . (It is sufficient that S satisfies the separation property T_1).

Prove that if $x \in S$ is an accumulation point of W , then every neighbourhood of x in S contains infinitely many different points of W .

An accumulation point $x \in S$ of W is a point for which every neighbourhood U of x (in S) contains at least one point $y \in W$, where $y \neq x$.

Let U_1 be any open neighbourhood of x , and choose $y_1 \in W \cap U_1$, such that $y_1 \neq x$. It follows from EXAMPLE 4.2 that $\{y_1\}$ is closed, if S is just a T_1 -space. Then $U_2 = U_1 \setminus \{y_1\}$ is an open neighbourhood of x , and we can choose $y_2 \in W \cap U_2 \setminus \{x\}$, i.e. $y_2 \neq x$ and $y_2 \neq y_1$.

Then consider the open set $U_3 = U_1 \setminus \{y_1, y_2\}$, etc.

In the n -th step we have an open neighbourhood

$$U_n = U_{n-1} \setminus \{y_1, y_2, \dots, y_{n-1}\}$$

of x , where $y_1, y_2, \dots, y_{n-1} \in W$ are mutually different, and where each of them is different from x . Then choose $y_n \in U_n \cap W$, such that $y_n \neq x$, and y_n different from all the previous chosen elements $\{y_1, y_2, \dots, y_2\}$.

Since

$$U_{n+1} = U_1 \setminus \{y_1, y_2, \dots, y_n\} \text{ is open and } x \in U_{n+1} \neq \emptyset,$$

the process never stops, and we have proved that any open neighbourhood of x contains infinitely many different elements from W .

If U is any neighbourhood of x , then it contains an *open* neighbourhood U_1 of x , thus $x \in U_1 \subseteq U$. Since already U_1 has the wanted property, the larger set U will also have it.

Example 4.4 Let (S, d) be a metric space. For an arbitrary non-empty subset W in S , we define a function $\varphi : S \rightarrow \mathbb{R}$ by

$$\varphi(x) = \inf\{d(x, y) \mid y \in W\} \quad \text{for } x \in S.$$

We call $\varphi(x)$ the distance from x to W , and write, accordingly,

$$\varphi(x) = d(x, W).$$

1. Let $x_1, x_2 \in S$ be arbitrary points in S .

First show that for an arbitrary point $y \in W$ it holds that

$$\varphi(x_1) \leq d(x_1, x_2) + d(x_2, y).$$

Next show that

$$|\varphi(x_1) - \varphi(x_2)| \leq d(x_1, x_2),$$

and conclude from this fact that φ is (uniformly) continuous on S .

2. Show that

$$d(x, W) = \varphi(x) \iff x \in \overline{W},$$

where \overline{W} as usual denotes the closure of W .

3. Let A_1 and A_2 be disjoint, non-empty closed subsets in the metric space (S, d) . Show that there exist disjoint, open sets U_1 and U_2 in S , such that $A_1 \subseteq U_1$ and $A_2 \subseteq U_2$.

Hint: Consider the distance functions $\varphi_1(x) = d(x, A_1)$ and $\varphi_2(x) = d(x, A_2)$.

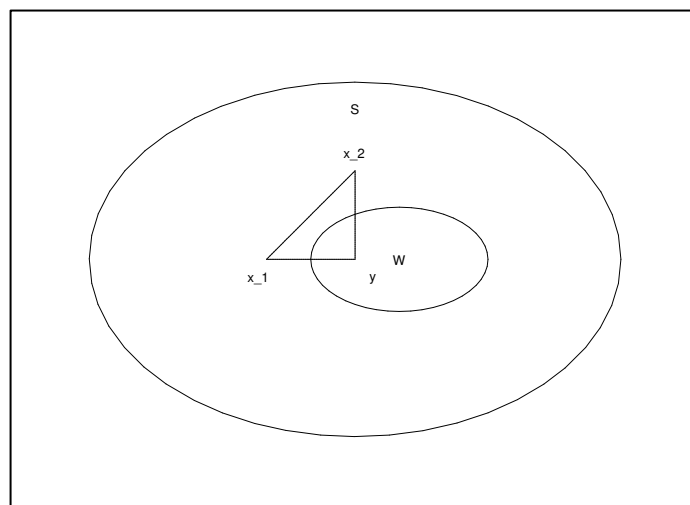

1. This example is an exercise in the triangle inequality. Let $y \in W$ and $x_1, x_2 \in S$. Then

$$\varphi(x_1) = \inf\{d(x_1, \tilde{y}) \mid \tilde{y} \in W\} \leq d(x_1, y) \leq d(x_1, x_2) + d(x_2, y).$$

It follows from

$$\varphi(x_1) \leq d(x_1, x_2) + d(x_2, y) \quad \text{for every } y \in W,$$

that

$$\varphi(x_1) \leq d(x_1, x_2) + \inf\{d(x_2, y) \mid y \in W\} = d(x_1, x_2) + \varphi(x_2),$$

hence

$$\varphi(x_1) - \varphi(x_2) \leq d(x_1, x_2).$$

An interchange of x_1 and x_2 gives

$$\varphi(x_2) - \varphi(x_1) \leq d(x_2, x_1) = d(x_1, x_2),$$

hence

$$|\varphi(x_1) - \varphi(x_2)| \leq d(x_1, x_2).$$

Now we can independently of the points x_1 and $x_2 \in S$ to every $\varepsilon > 0$ choose $\delta = \varepsilon > 0$, such that

$$d(x_1, x_2) < \varepsilon \quad \text{implies that} \quad |\varphi(x_1) - \varphi(x_2)| < \varepsilon,$$

hence φ is uniformly continuous.

2. Assume that $\varphi(x) = 0$, i.e.

$$\varphi(x) = \inf\{d(x, y) \mid y \in W\} = 0.$$

Then there exists a sequence $\{y_n\} \subseteq W$, such that $d(x, y_n) < \frac{1}{n}$, and every open ball $B_{1/n}(x)$ of centre x and radius $\frac{1}{n}$ contains points from W ,

$$W \cap B_{1/n}(x) \neq \emptyset \quad \text{for every } n \in \mathbb{N}.$$

Then $x \in \overline{W}$.

Conversely, if $x \in \overline{W}$, then there exists a sequence $\{y_n\} \subseteq W$, such that

$$d(x, y_n) < \frac{1}{n}.$$

Then

$$0 \leq \varphi(x) = \inf\{d(x, y) \mid y \in W\} \leq \inf\{d(x, y_n) \mid y \in W\} = 0,$$

and hence $\varphi(x) = 0$.

3. Let $\varphi_1(x) = d(x, A_1)$ and $\varphi_2(x) = d(x, A_2)$. If $x_1 \in A_1$ and $x_2 \in A_2$, then clearly

$$\varphi_2(x_2) \leq d(x_1, x_2) \quad \text{and} \quad \varphi_1(x_1) \leq d(x_1, x_2).$$

We define the open sets

$$U_1(x_1) = \left\{ y \in S \mid d(x_1, y) < \frac{1}{3} \varphi_2(x_1) \right\},$$

$$U_1 = \bigcup_{x_1 \in A_1} U_1(x_1) \quad \text{open,} \quad U_1 \supseteq A_1,$$

and

$$U_2(x_2) = \left\{ y \in S \mid d(x_2, y) < \frac{1}{3} \varphi_1(x_2) \right\},$$

$$U_2 = \bigcup_{x_2 \in A_2} U_2(x_2) \quad \text{open,} \quad U_2 \supseteq A_2.$$

We shall prove that $U_1 \cap U_2 = \emptyset$.

Indirect proof. Assume that there exists $z \in U_1 \cap U_2$. Then there are an $x_1 \in A_1$ and an $x_2 \in A_2$, such that also

$$z \in U_1(x_1) \cap U_2(x_2).$$

Then we get the following contradiction,

$$0 < d(x_1, x_2) \leq d(x_1, z) + d(z, x_2) \leq \frac{1}{3} \varphi_1(x_2) + \frac{1}{3} \varphi_2(x_1) \leq \frac{2}{3} d(x_1, x_2).$$

This cannot be true, so our assumption must be wrong. We therefore conclude that $U_1 \cap U_2 = \emptyset$, and the claim is proved.

Example 4.5 Let $S = \{x \in \mathbb{R} \mid 0 \leq x < 1\}$. Consider the family of subsets \mathcal{T} in S consisting of the empty set \emptyset and every subset $U \subseteq S$ of the form

$$U = \{x \in \mathbb{R} \mid 0 \leq x < k\}$$

for a number k with $0 < k \leq 1$.

1. Show that \mathcal{T} is a topology on S .
2. Show that in the topological space (S, \mathcal{T}) , the sequence $\left(x_n = \frac{1}{n+1}\right)$ will have every point in S as limit point.
3. Examine if the topology \mathcal{T} stems from a metric on S .

1. **TOP 1.** Let $U_i = \{x \in \mathbb{R} \mid 0 \leq x < k_i\}$, $i \in I$. Then

$$\bigcup_{i \in I} U_i = \{x \in \mathbb{R} \mid 0 \leq x < \sup_{i \in I} k_i\} \in \mathcal{T},$$

because

$$\sup\{k_i \mid i \in I\} \in]0, 1].$$

- TOP 2.** If $I = \{1, 2, \dots, n\}$, then

$$\min_{k=1, \dots, n} k_i \in]0, 1],$$

hence

$$\bigcap_{i=1}^n U_i = \{x \in \mathbb{R} \mid 0 \leq x < \min_{i=1, \dots, n} k_i\} \in \mathcal{T}.$$

- TOP 3.** Finally, it is obvious that $\emptyset, S \in \mathcal{T}$.

We have proved that \mathcal{T} is a topology.

2. Let $x \in [0, 1[$. Then any open neighbourhood of x is of the form

$$U = \{y \in \mathbb{R} \mid 0 \leq y < k\}, \quad \text{where } x < k.$$

It follows from $x_n = \frac{1}{n+1} < k$ for $n > \frac{1}{k} - 1 = n_0$ that $x_n \rightarrow x$ for $n \rightarrow \infty$. Since $x \in S$ is chosen arbitrarily, we conclude that $x_n \rightarrow x$ for $n \rightarrow \infty$ for every $x \in S$ in \mathcal{T} .

3. The topology can never be generated of a metric. In fact, a metric space is automatically a Hausdorff space, and in a Hausdorff space S any sequence (x_n) has at most one limit point. In the present example every point of S is a limit point.

5 Sequences

Example 5.1 Deduce the existence of a supremum from the principle of nested intervals.

We assume that if

$$[a_1, b_1] \supseteq [a_2, b_2] \supseteq \cdots \supseteq [a_n, b_n] \supseteq \cdots$$

is a decreasing sequence of closed intervals, where the lengths of the intervals $|b_n - a_n| \rightarrow 0$ for $n \rightarrow \infty$, then the intersection $\bigcap_{n=1}^{\infty} [a_n, b_n]$ becomes just one number.

We shall *prove* that every non-empty bounded subset A of \mathbb{R} has a smallest upper bound, $\sum A$.

Let $A \neq \emptyset$ be bounded, i.e. there exist a_1 and b_1 , such that $A \subseteq [a_1, b_1]$.

Define $c_1 = \frac{1}{2}(a_1 + b_1)$ as the midpoint of the interval $[a_1, b_1]$.

1. If $x < c_1$ for every $x \in A$, then put

$$a_2 = a_1 \quad \text{and} \quad b_2 = c_1.$$

Please click the advert

THE MILKWAY
LAUNCHING GRADUATE CAREERS

MILKROUND SYSTEM
Become a business star with internships, placements, graduate jobs & schemes from leading companies.
www.milkround.com

PLANET CAREER ADVICE
Inhabited by insights into business careers and orbited by application advice.

FIRST CONTACT
Get matched to top business employers via intelligent emails landing in your inbox.

Milkround.com: rated the #1 graduate recruitment website in the UK Graduate Careers Survey 2009 of 16,000 university finalists.

Milkround.com

Download free books at BookBooN.com

2. If there exists an $x \in A$, such that $x \geq c_1$, we put

$$a_2 = c_1 \quad \text{and} \quad b_2 = b_1.$$

When this process is repeated, we obtain a decreasing sequence

$$[a_1, b_1] \supseteq [a_2, b_2] \supseteq \cdots \supseteq [a_n, b_n] \supseteq \cdots,$$

of intervals, where

$$|b_n - a_n| = \frac{1}{2^{n-1}} |b_1 - a_1| \rightarrow 0 \quad \text{for } n \rightarrow \infty,$$

hence by the assumption,

$$\bigcap_{n=1}^{\infty} [a_n, b_n] = \{x_0\}.$$

Furthermore, $a_n \nearrow x_0$ and $b_n \searrow x_0$. Since the construction secures that every b_n is an upper bound of A , thus

$$x \leq b_n \quad \text{for every } x \in A \text{ and every } n \in \mathbb{N},$$

we conclude that x_0 is also an upper bound of A .

Since none of the a_n is an upper bound of A , because we by the construction always can find an $x_n \in A$, such that $a_n < x_n$, and since $a_n \nearrow x_0$, we infer that x_0 is the smallest upper bound of A , hence $x_0 = \sup A$.

Example 5.2 Let S be a topological space, and let (f_n) , or in more detail $f_1, f_2, \dots, f_n, \dots$, be a sequence of continuous functions $f_n : S \rightarrow \mathbb{R}$, such that for all $x \in S$ it holds that

- (i) $f_n(x) \geq 0$,
- (ii) $f_1(x) \geq f_2(x) \geq \dots \geq f_n(x) \geq \dots$,
- (iii) $\lim_{n \rightarrow \infty} f_n(x) = 0$.

In other words: The decreasing sequence of functions (f_n) converges pointwise to the 0-function. For $\varepsilon > 0$ and $n \in \mathbb{N}$ we set

$$U_n(\varepsilon) = \{x \in S \mid 0 \leq f_n(x) < \varepsilon\}.$$

1. Show that $U_n(\varepsilon)$ is an open set in S .
2. Show that for fixed $\varepsilon > 0$, the collection of sets $\{U_n(\varepsilon) \mid n \in \mathbb{N}\}$ defines an open covering of S .
3. Now assume that S is compact. Show then that for every $\varepsilon > 0$ there is an $n_0 \in \mathbb{N}$, such that for all $n \geq n_0$ it holds that

$$0 \leq f_n(x) < \varepsilon \quad \text{for all } x \in S;$$

or written with quantifiers,

$$\forall \varepsilon > 0 \exists n_0 \in \mathbb{N} \forall n \in \mathbb{N} : n \geq n_0 \implies \forall x \in S : 0 \leq f_n(x) < \varepsilon.$$

We conclude that under the given assumptions, the sequence of functions (f_n) converges uniformly to the 0-function.

This result is due to the Italian mathematician Ulisse Dini (1845 – 1918) and is known as DINI'S THEOREM.

4. Is it of importance that S is compact in (3)?

1. Since every $f_n \geq 0$, and each f_n is continuous, we get

$$U_n(\varepsilon) = \{x \in S \mid 0 \leq f_n(x) < \varepsilon\} = f_n^{-1}(] - \infty, \varepsilon[) \quad \text{open.}$$

2. Since

$$f_1(x) \geq f_2(x) \geq \dots \geq f_n(x) \geq \dots \rightarrow 0,$$

there is to every $\varepsilon > 0$ and every $x \in S$ an $n \in \mathbb{N}$, such that $0 \leq f_n(x) < \varepsilon$, i.e. $x \in U_n(\varepsilon)$. Since this holds for every $x \in S$, we have

$$S \subseteq \bigcup_{n=1}^{\infty} U_n(\varepsilon),$$

so $\{U_n(\varepsilon) \mid n \in \mathbb{N}\}$ is an open covering of S , because every $U_n(\varepsilon)$ is an open set.

3. If S is compact, then the open covering $\{U_n(\varepsilon) \mid n \in \mathbb{N}\}$ of S can be thinned out to a finite covering,

$$S \subseteq U_{n_1}(\varepsilon) \cup U_{n_2}(\varepsilon) \cup \cdots \cup U_{n_k}(\varepsilon).$$

It remains to notice that if $x \in U_{n_0}(\varepsilon)$, then $x \in U_n(\varepsilon)$ for every $n \geq n_0$, hence

$$U_{n_0}(\varepsilon) \subseteq U_{n_0+1}(\varepsilon) \subseteq \cdots.$$

This follows from $f_{n+1}(x) \leq f_n(x) < \varepsilon$. Then we get for $n_1 < n_2 < \cdots < n_k$,

$$S = U_{n_1}(\varepsilon) \cup U_{n_2} \cup \cdots \cup U_{n_k}(\varepsilon) = U_{n_k}(\varepsilon),$$

hence

$$S = \{x \in S \mid f_{n_k}(x) < \varepsilon\}.$$

If $n \geq n_k$, then it follows that

$$0 \leq f_n(x) \leq f_{n_k}(x) < \varepsilon,$$

hence

$$0 \leq f_n(x) < \varepsilon \quad \text{for } n \geq n_k,$$

and we have proved Dini's theorem.

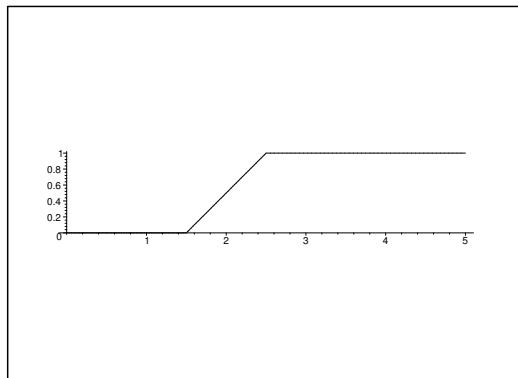

Figure 15: A principal sketch of the graph of f_n .

4. The assumption of compactness is of course important. In order to see this, we must construct an example, in which S is not compact, where the $f_n \geq 0$ are all continuous and tend pointwise and decreasingly towards 0, and where the convergence is not uniform.

Consider $S = [0, \infty[$, which clearly is not compact. We put

$$f_n(x) = \begin{cases} 0, & \text{for } x \in [0, n-1[, \\ x - n + 1, & \text{for } x \in [n-1, n[, \\ 1, & \text{for } x \in [n, \infty[, \end{cases} \quad n \in \mathbb{N}.$$

Then every $f_n \geq 0$ is continuous and $f_n(x) \searrow 0$ for $n \rightarrow \infty$ for every $x \in S$, so the convergence is decreasing. Also, to every $n_0 \in \mathbb{N}$ there exist an $n \geq n_0$ and an $x \in S$, such that $f_n(x) = 1$. This holds for all $n \geq n_0$ and all $x \geq n$, and the convergence is not uniform.

Remark 5.1 The example above illustrates the common observation in Mathematics, that if something can go wrong, it can go really wrong! \diamond

Example 5.3 Let $f, g : [a, b] \rightarrow \mathbb{R}$ be continuous functions defined in a closed and bounded interval $[a, b]$. Assume that $f(x) < g(x)$ for every $x \in [a, b]$.

Show that

$$K = \{(x, y) \in \mathbb{R}^2 \mid a \leq x \leq b, f(x) \leq y \leq g(x)\}$$

is a compact subset in \mathbb{R}^2 .

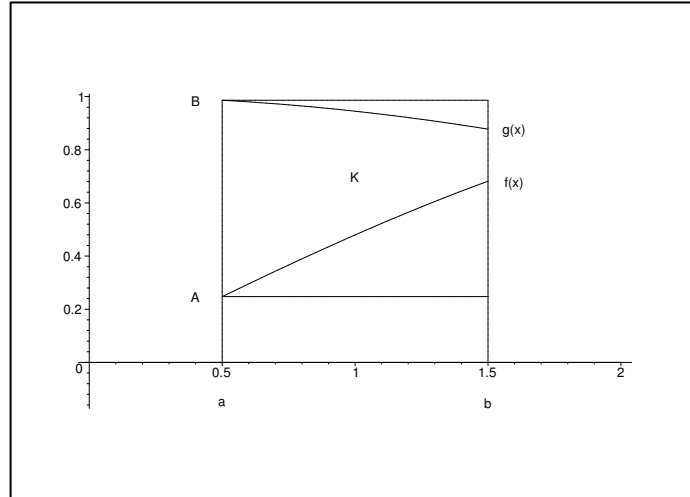

Since $[a, b]$ is compact, and f and g are continuous, f has a minimum, $f(x_1) = A$, and g a maximum $g(x_2) = B$, and we infer that

$$K = \{(x, y) \in \mathbb{R}^2 \mid a \leq x \leq b, f(x) \leq y \leq g(x)\} \subseteq [a, b] \times [A, B],$$

proving that K is bounded.

Furthermore, K is closed. This is proved by showing that the complementary set is open. There is nothing to prove if $(x, y) \in \mathbb{R}^2 \setminus K$ satisfies one of the following conditions,

$$i) \ x < a, \quad ii) \ x > b, \quad iii) \ y < A, \quad iv) \ y > B.$$

Let

$$(x_0, y_0) \in ([a, b] \times [A, B]) \setminus K.$$

We may assume that $y_0 < f(x_0)$, because the other cases are treated analogously. Using that f is continuous we can to

$$\varepsilon = \frac{1}{3} \{f(x_0) - y_0\} > 0$$

find a $\delta > 0$, such that

$$|f(x) - f(x_0)| < \varepsilon \quad \text{for } |x - x_0| < \delta \text{ and } x \in [a, b].$$

Then $]x_0 - \delta, x_0 + \delta[\times]y_0 - \varepsilon, y_0 + \varepsilon[$ and K are disjoint sets, hence the complementary set of K is open. This implies that K is closed.

We have proved that K is closed and bounded in \mathbb{R}^2 , so K is compact.

Example 5.4 Let $K_1 \supseteq K_2 \supseteq \dots \supseteq K_n \supseteq \dots$ be a descending sequence of non-empty subsets in a Hausdorff space S . Show that the intersection of sets $\bigcap_{n=1}^{\infty} K_n$ is non-empty.

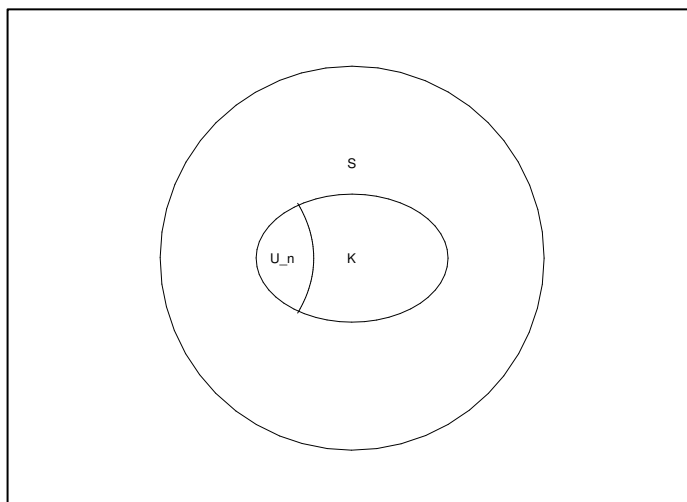

Indirect proof. Assume that $\bigcap_{n=1}^{\infty} K_n = \emptyset$, and consider the subspace topology \mathcal{T}_K of $K = K_1$. Then

$$U_n = K \setminus K_n \quad \text{open in } \mathcal{T}_K.$$

We have

$$\bigcup_{n=1}^{\infty} U_n = \bigcup_{n=1}^{\infty} (K \setminus K_n) = K \setminus \bigcap_{n=1}^{\infty} K_n = K,$$

where we in the latter equality have applied the assumption that $\bigcap_{n=1}^{\infty} K_n = \emptyset$. Since K is compact in a Hausdorff space, and $\bigcup_{n=1}^{\infty} U_n$ is an open covering, and

$$\emptyset = U_1 \subseteq U_2 \subseteq \dots \subseteq U_n \subseteq \dots,$$

we can extract from this covering a finite covering (with $n_1 < n_2 < \dots < n_k$),

$$K = K_1 \subseteq \bigcup_{j=1}^k U_{n_j} = U_{n_k} = K \setminus K_{n_k}.$$

Now, $K_{n_k} \subseteq K$ and $K = K \setminus K_{n_k}$, so $K_{n_k} = \emptyset$ contradicting the assumption that none of the K_n is empty.

Hence our assumption is wrong, and we infer that

$$\bigcap_{n=1}^{\infty} K_n \neq \emptyset.$$

Example 5.5 Let $S = \mathbb{N} \cup \{0\}$ be the set of non-negative integers. For every natural number $n \in \mathbb{N}$ we define a subset U_n in S by

$$U_n = \{n \cdot p \in S \mid p = 0, 1, 2, \dots\}.$$

1. Show that for all $n, m \in \mathbb{N}$, the intersection $U_n \cap U_m$ has the form U_k for a suitable $k \in \mathbb{N}$.

Consider the family \mathcal{T} of subsets in S which consists of the empty set \emptyset and all subsets U in S that can be written as a union of sets from $\{U_n \mid n \in \mathbb{N}\}$, i.e.

$$U = \bigcup_{\alpha \in A} U_{n_\alpha}.$$

2. Show that \mathcal{T} is a topology on S .

(The system of subsets $\{U_n \mid n \in \mathbb{N}\}$ in S is called a basis for the topology \mathcal{T} .)

3. Show that the sequence $(x_n = n!)$ will converge to every point in the topological space (S, \mathcal{T}) .

1. Let $k \in \mathbb{N}$ be the smallest number which can be divided by both m and n . Then we get

$$U_n \cap U_m = U_k.$$

2. The result of **1.** implies that finite intersections of sets of the type U_n again can be written as an U_k . When we form the topology by adding any union of sets of type U_k as open sets, supplied by \emptyset , it only remains to note that the whole space $S = U_1$ trivially belongs to \mathcal{T} . This proves that \mathcal{T} is a topology.

3. Let $y_0 \in \mathbb{N}$. Then the smallest open set, which contains y_0 , must necessarily be U_{y_0} . If we choose $n_0 \in \mathbb{N}$, such that $n_0! = y_0 \cdot k$ for some $k \in \mathbb{N}$, it follows that $n! \in U_{y_0}$ for every $n \geq n_0$.

If instead $y_0 = 0 \in S$, then every U_k is a neighbourhood. Choose $n_0 \in \mathbb{N}$, such that $n_0! = k \cdot p$, $p \in \mathbb{N}$, and we obtain that $n! \in U_k$ for $n \geq n_0$.

This implies by the definition of convergence in topological spaces that $(n!)$ converges towards every point in S .

6 Semi-continuity

Example 6.1 Let S be a Hausdorff space. A function $f : S \rightarrow \mathbb{R}$ is said to be lower semi-continuous, if the following condition is satisfied:

For every $x \in S$ and every $\varepsilon > 0$ there exists a neighbourhood N and an x in S , such that

$$f(x) - \varepsilon < f(y) \quad \text{for } y \in N.$$

1. Show that a lower semi-continuous function $f : S \rightarrow \mathbb{R}$ is bounded from below on every sequentially compact subset K in S .

HINT: You can prove this indirectly.

2. Show that a lower semi-continuous function $f : S \rightarrow \mathbb{R}$ assumes a minimum value on every sequentially compact subset K in S .

HINT: Construct a sequence (x_n) on K for which

$$\lim_{n \rightarrow \infty} f(x_n) = \inf f(K),$$

and make use of this to determine a point $x_0 \in K$, such that

$$f(x_0) = \inf f(K).$$

(In a suitable setting this is the so-called *direct method* the calculus of variations, and the sequence (x_n) is called a minimizing sequence.)

Please click the advert



CHALLENGE
YOURSELF

WWW.STUDYINSWEDEN.SE

Today's job market values ambitious, innovative, perceptive team players. Swedish universities foster these qualities through a forward-thinking culture where you're close to the latest ideas and global trends.

Whatever your career goals may be, studying in Sweden will give you valuable skills and a competitive advantage for your future. www.studyinsweden.se

Si.
Swedish Institute

Download free books at BookBooN.com

1. *Indirect proof.* Let K be sequentially compact. We assume that f is *not* bounded from below on K . This means that we can find points $x_n \in K$, such that $f(x_n) < -n$, $n \in \mathbb{N}$. We may assume that all $(x_n) \subseteq K$ are mutually different.

Since K is sequentially compact, (x_n) has an accumulation point $x_0 \in K$.

Since f is lower semi-continuous in x_0 , we can to every $\varepsilon > 0$ find a neighbourhood N of x_0 in S , such that

$$f(x_0) - \varepsilon < f(y) \quad \text{for all } y \in N.$$

Since x_0 is an accumulation point, there are (infinitely many) $x_n \in N$ for which

$$-n < f(x_0) - \varepsilon.$$

Since also $x_n \in N$, it follows that

$$f(x_n) < -n < f(x_0) - \varepsilon < f(x_n),$$

which is a contradiction.

We have proved that every lower semi-continuous function $f : S \rightarrow \mathbb{R}$ is bounded from below on every sequentially compact set.

2. We infer from the definition of $\inf f(K)$ that there exists a sequence $(x_n) \subseteq K$, such that

$$\lim_{n \rightarrow \infty} f(x_n) = \inf f(K).$$

The sequence (x_n) itself needs not be convergent, but since it has an accumulation point $x_0 \in K$, we can extract from it an subsequence which converges towards x_0 . The image of the sequence will still converge towards $\inf f(K)$, so we may already from the beginning assume that $(x_n) \rightarrow x_0$.

By assumption, f is lower semi-continuous in x_0 , so to every $\varepsilon > 0$ there is a neighbourhood N of x_0 , such that

$$f(x_0) - \varepsilon < f(y) \quad \text{for every } y \in N.$$

Using that N is a neighbourhood of x_0 and that $x_n \rightarrow x_0$ for $n \rightarrow \infty$, we infer that there exists an m , such that $x_n \in N$ for all $n \geq m$, thus

$$f(x_0) - \varepsilon < f(x_n) \quad \text{for all } n \geq m.$$

The right hand side is convergent for $n \rightarrow \infty$, hence

$$f(x_0) - \varepsilon \leq \lim_{n \rightarrow \infty} f(x_n) = \inf f(K) \quad \text{for every } \varepsilon > 0.$$

Finally, we get by taking the limit $\varepsilon \searrow 0$,

$$\inf f(K) \leq f(x_0) \leq \inf f(K),$$

proving that

$$f(x_0) = \inf f(K) \quad [= \min f(K)].$$

Example 6.2 Let $f : \mathbb{R} \rightarrow \mathbb{R}$ be a differentiable function with bounded differential quotient. Show that f is uniformly continuous.

HINT. You can use the classical Mean Value Theorem.

The differential quotient $Df(z)$ is bounded, so

$$\sup_{z \in \mathbb{R}} |Df(x)| = C < +\infty.$$

Using the Mean Value Theorem we get for any x and y that there exists an z between x and y , such that

$$f(y) - f(x) = Df(z) \cdot (y - x), \quad z = z(x, y),$$

hence

$$|f(y) - f(x)| = |Df(z)| \cdot |y - x| \leq C \cdot |y - x|.$$

To any $\varepsilon > 0$ we choose $\delta = \frac{\varepsilon}{C}$, such that

$$|y - x| < \delta \quad \text{implies that} \quad |f(y) - f(x)| < \varepsilon,$$

where δ is independent of x and y . This means that f is uniformly continuous.

Example 6.3 A subset K in a metric space (S, d) is called precompact if for every $\varepsilon > 0$ there exist finitely many points $x_1, \dots, x_p \in K$ such that

$$K \subseteq B_\varepsilon(x_1) \cup \dots \cup B_\varepsilon(x_p).$$

1. Show that a subset $K \subseteq \mathbb{R}^n$ in the space \mathbb{R}^n (with Euclidean metric) is precompact if and only if it is bounded.
2. Let $f : X \rightarrow Y$ be a mapping between the metric spaces (X, d_X) and (Y, d_Y) , and let $K \subseteq X$ be a precompact subset in X . Show that if f is uniformly continuous in K , then the image set $f(K) \subseteq Y$ is precompact in Y .

1. Let K be precompact, and put $\varepsilon = 1$. There are points x_1, \dots, x_p , such that

$$K \subseteq B_1(x_1) \cup \dots \cup B_1(x_p).$$

Defining

$$R = \max\{d(x_1, x_j) \mid j = 1, \dots, p\} + 1,$$

it follows that $B_1(x_j) \subseteq B_R(x_1)$ for every $j \in \{1, \dots, p\}$, thus

$$K \subseteq B_1(x_1) \cup \dots \cup B_1(x_p) \subseteq B_R(x_1),$$

and K is bounded.

The phrase “ K bounded” means that “ K can be shut up” in a ball. Therefore, in order to prove the claim in the opposite direction it suffices to show that whenever a ball $B_R(x_0)$ and an $\varepsilon > 0$ are given, then there exist finitely many points $x_1, \dots, x_p \in S$, such that

$$B_R(x_0) \subseteq B_\varepsilon(x_1) \cup B_\varepsilon(x_2) \cup \dots \cup B_\varepsilon(x_p).$$

Remark 6.1 It is at this point that we use that the metric is *Euclidean*. In general, the claim is wrong for metric spaces, which is illustrated by the following example.

Let $X = \mathbb{R}$ be equipped with the metric

$$d(x, y) = \begin{cases} 1 & \text{for } x \neq y, \\ 0 & \text{for } x = y. \end{cases}$$

A routine check shows that this is indeed a metric. Then $\mathbb{R} \subseteq B_1(0)$ is clearly bounded (the radius is 1).

If $0 < \varepsilon < 1$, then $B_\varepsilon(x) = \{x\}$, and

$$\mathbb{R} = \bigcup_{x \in \mathbb{R}} \{x\}$$

is obviously not precompact.

This example shows that we must require more of the metric – it is quite natural here to assume that it is Euclidean. \diamond

We consider \mathbb{R}^2 with the usual Euclidean metric. Choose any $\varepsilon > 0$, and assume that

$$K \subseteq [a_1, b_1] \times [a_2, b_2] \times \cdots \times [a_n, b_n].$$

Each edge $[a_j, b_j]$ can be divided into at most

$$\frac{\sqrt{n}}{2\varepsilon} |b_j - a_j| + 1 \text{ intervals of length } \frac{2\varepsilon}{\sqrt{n}}.$$

This implies that

$$M \leq \frac{1}{(2\varepsilon)^n} (\sqrt{n})^n \prod_{j=1}^n \{|b_j - a_j| + 1\}$$

n -dimensional cubes cover K . Choose the centre of each of these cubes as centre of balls of radius ε . Then every cube is again covered by a finite number of balls, and the claim follows.

2. If f is uniformly continuous on a precompact set K , then $\delta = \delta(\varepsilon)$ depends only on $\varepsilon > 0$ and not on $x, y \in K$. Hence, if

$$d_X(x, y) < \delta(\varepsilon), \quad \text{then} \quad d_Y(f(x), f(y)) < \varepsilon,$$

and thus

$$(2) \quad f(B_{X,\delta}(x)) \subseteq B_{Y,\varepsilon}(f(x)).$$

The set K is precompact, so there exist $x_1, \dots, x_p \in K$, such that

$$K \subseteq B_{X,\delta}(x_1) \cup \cdots \cup B_{X,\delta}(x_p).$$

It follows from (2) that

$$\begin{aligned} f(K) &\subseteq f(B_{X,\delta}(x_1)) \cup \cdots \cup f(B_{X,\delta}(x_p)) \\ &\subseteq B_{Y,\varepsilon}(f(x_1)) \cup \cdots \cup B_{Y,\varepsilon}(f(x_p)). \end{aligned}$$

Since this holds for every $\varepsilon > 0$, we conclude that $f(K)$ is precompact.

Example 6.4 Let T be a point set with more than one element equipped with the discrete topology.

1. Show that a topological space S is connected if and only if every continuous mapping $f : S \rightarrow T$ is constant.
2. Let $\{W_i \mid i \in I\}$ be a family of connected subsets in a topological space S , such that for every pair of sets W_i and W_j from the family it holds that $W_i \cap W_j \neq \emptyset$. Then show that the union $\bigcup_{i \in I} W_i$ is a connected subset in S .

1. Let $f : S \rightarrow T$ be a continuous function, which is not constant, with e.g. $\{t_1, t_2\} \subseteq f(S)$. Since $\{t_1\}$ and $\{t_2\}$ are open, both $f^{-1}(\{t_1\})$ and $f^{-1}(\{t_2\})$ are open, disjoint and non-empty, and S is not connected.

Hence we get by contraposition that if S is connected, then every continuous function $f : S \rightarrow T$ is constant.

If $S = S_1 \cup S_2$ is not connected, i.e. S_1 and S_2 are open, non-empty and disjoint, then we can define a continuous function $f : S \rightarrow T$ by

$$f(x) = \begin{cases} t_1, & \text{for } x \in S_1, \\ t_2, & \text{for } x \in S_2. \end{cases}$$

Please click the advert



DIVERSE - INNOVATIVE - INTERNATIONAL

Are you considering a European business degree?

Copenhagen Business School is one of the largest business schools in Northern Europe with more than 15,000 students from Europe, North America, Australia and Asia.

Are you curious to know how a modern European business school competes with a diverse, innovative and international study environment?

Please visit Copenhagen Business School at www.cbs.dk



Copenhagen Business School
HANDELSHØJSKOLEN

Diversity creating knowledge



In fact,

$$f^{\circ-1}(\{t_1\}) = S_1 \quad \text{and} \quad f^{\text{circ-1}}(\{t_2\}) = S_2,$$

and

$$f^{\circ-1}(U) = \emptyset \quad \text{for } U \subseteq S \setminus \{t_1, t_2\}.$$

Clearly, f is not constant, and the claim is proved.

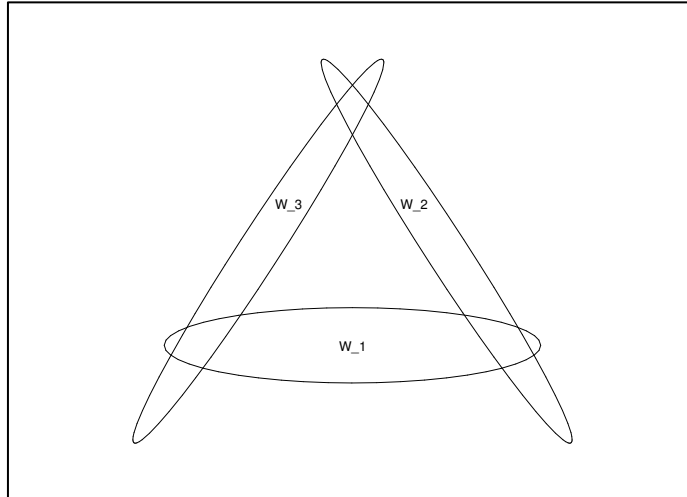

2. Since $f_i : W_i \rightarrow T$ is continuous, so

$$f_i(x) = t_i \in T \quad \text{for } x \in W_i,$$

and we infer that if

$$f : \bigcup_{i \in I} W_i \rightarrow T \quad \text{is continuous,}$$

then $f(x) = f_i(x) = t_i$ for $x \in W_i$, $i \in I$.

Since there is an $x \in W_i \cap W_j$, we must have

$$f(x) = f_i(x) = t_i = f_j(x) = t_j,$$

thus $t_i = t_j$ for all $i, j \in I$. This implies that the constant functions

$$f : \bigcup_{i \in I} W_i \rightarrow T$$

are the only continuous functions, and we conclude from **1.** that $\bigcup_{i \in I} W_i$ is connected.

Example 6.5 Prove the following theorem: Let M be an arbitrary subset in the number space \mathbb{R}^k with the usual topology, and let $\{U_i \mid i \in I\}$ be an arbitrary system of open sets in \mathbb{R}^k that covers M . Then, either there exists a finite subsystem $\{U_{i_1}, \dots, U_{i_n}\}$, or, there exists a countable subsystem $\{U_{i_1}, U_{i_2}, \dots, U_{i_n}, \dots\}$ that covers M .

The theorem is due to the Finnish mathematician Ernst Lindelöf (1870–1946), and it is called Lindelöf's covering theorem.

HINT: consider the following system of open balls in \mathbb{R}^k :

$$B_r(x) \mid r \in \mathbb{R}^+ \text{ is rational; } x \in \mathbb{R}^k \text{ has rational coordinates}.$$

We mention without proof that this system is countable.

Once the hint is given the example becomes extremely simple. In fact,

$$\mathbb{R} \subseteq \bigcup \{B_r(x) \mid r \in \mathbb{Q}^+, x \in \mathbb{Q}^k\} = \bigcup_{n=1}^{\infty} B_n,$$

where \mathbb{Q} denotes the set of rational numbers.

Each element U_i , $i \in I$, can as an open set be written

$$U_i = \bigcup_{n \in I_i} B_n, \quad \text{where } I_i \subseteq \mathbb{N}, \text{ thus } I_i \text{ is countable.}$$

Since $\{U_i \mid i \in I\}$ covers M , there exists a subsystem $\{B_n \mid n \in J\}$, $J \subseteq \mathbb{N}$, which also covers M , (e.g. $J = \bigcup_{i \in I} I_i$).

The subsystem $\{B_n \mid n \in J\}$ is finite or countable, and every B_n is contained in some U_{i_n} for $n \in J$. Hence, we choose $\{U_{i_n} \mid n \in J\}$, such that

$$M \subseteq \bigcup_{n \in J} B_n \subseteq \bigcup_{n \in J} U_{i_n},$$

(finite or countable union).

7 Connected sets, differentiation a.o.

Example 7.1 Let E be a subset in the topological space S . Show that if E is connected, then the closure \overline{E} is also connected.

Let T contain at least two points, and let T be equipped with the discrete topology, thus every point $\{t\} \subset T$ is both open and closed.

Let $\varphi : S \rightarrow T$ be a continuous mapping. Since $\varphi|_E : E \rightarrow T$ is continuous and E is connected, we conclude that $\varphi(x) = t_0 \in T$, $x \in E$ is constant on E .

We get \overline{E} by adding the boundary ∂E to E , thus \overline{E} is the set of all contact points. Therefore, $\varphi(x) = t_0 \in T$ is constant on \overline{E} , because we get the values on ∂E by continuous extension, i.e.

$$x_n \rightarrow x_0 \in \overline{E} \quad \text{implies} \quad \varphi(x_0) = \lim \varphi(x_n) = \lim t_0 = t_0.$$

Please click the advert



Sharp Minds - Bright Ideas!

Employees at FOSS Analytical A/S are living proof of the company value - First - using new inventions to make dedicated solutions for our customers. With sharp minds and cross functional teamwork, we constantly strive to develop new unique products - Would you like to join our team?

FOSS works diligently with innovation and development as basis for its growth. It is reflected in the fact that more than 200 of the 1200 employees in FOSS work with Research & Development in Scandinavia and USA. Engineers at FOSS work in production, development and marketing, within a wide range of different fields, i.e. Chemistry, Electronics, Mechanics, Software, Optics, Microbiology, Chemometrics.

We offer
A challenging job in an international and innovative company that is leading in its field. You will get the opportunity to work with the most advanced technology together with highly skilled colleagues.

Read more about FOSS at www.foss.dk - or go directly to our student site www.foss.dk/sharpminds where you can learn more about your possibilities of working together with us on projects, your thesis etc.

The Family owned FOSS group is the world leader as supplier of dedicated, high-tech analytical solutions which measure and control the quality and production of agricultural, food, pharmaceutical and chemical products. Main activities are initiated from Denmark, Sweden and USA with headquarters domiciled in Hillerød, DK. The products are marketed globally by 23 sales companies and an extensive net of distributors. In line with the corevalue to be 'First', the company intends to expand its market position.







Dedicated Analytical Solutions

FOSS
 Slangerupgade 69
 3400 Hillerød
 Tel. +45 70103370
www.foss.dk

Example 7.2 Let (S, d) be a metric space. For an arbitrary pair of non-empty subsets A and B in S , we define the distance from A to B , denoted $d(A, B)$, by

$$d(A, B) = \inf\{d(x, y) \mid x \in A, y \in B\}.$$

1. As in EXAMPLE 4.4 we define for every $x \in S$ the distance from x to B by

$$d(x, B) = \inf\{d(x, y) \mid y \in B\}.$$

Argue that for arbitrary points $x \in A$ and $y \in B$ it holds that

$$d(A, B) \leq d(x, B) \quad \text{and} \quad \inf\{d(x', B) \mid x' \in A\} \leq d(x, y).$$

Utilize this to show that

$$d(A, B) = \inf\{d(x, B) \mid x \in A\}.$$

2. Show that if A is compact, then there exists a point $a_0 \in A$ such that

$$d(A, B) = d(a_0, B).$$

HINT: You can use that the function $\varphi : S \rightarrow \mathbb{R}$, defined by $\varphi(x) = d(x, B)$, is continuous.

Next show that if B is also compact, then there exists a point $b_0 \in B$ such that

$$d(A, B) = d(a_0, b_0).$$

3. Let K be a compact subset in S contained in the open set U in S , i.e. $K \subseteq U \subseteq S$. Show that there exists an $r \in \mathbb{R}^+$, such that $B_r(x) \subseteq U$ for every $x \in K$.

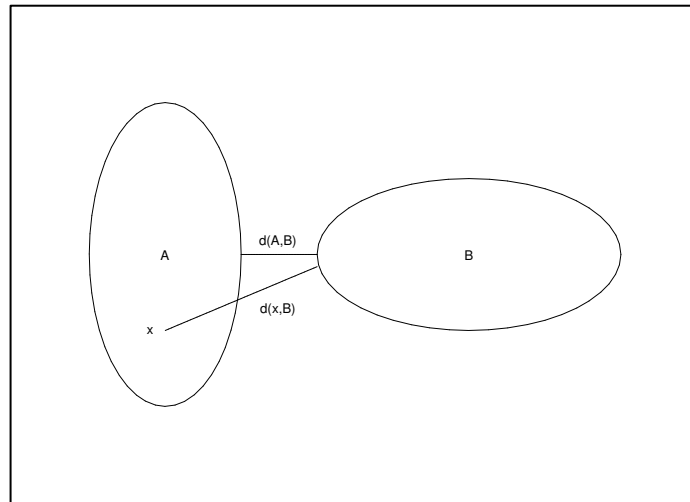

1. It follows from $d(x, B) = \inf\{d(x, y) \mid y \in B\}$, that

$$d(x, B) = d(\{x\}, B) \geq d(A, B) \quad \text{for every } x \in A,$$

and the claim is proved.

Furthermore,

$$d(x, B) = \inf\{d(x, y) \mid y \in B\} \leq d(x, y_0), \quad \text{for } y_0 \in B,$$

so

$$\inf\{d(x', B) \mid x' \in A\} \leq d(x, B) \leq d(x, y) \quad \text{for } x \in A \text{ and } y \in B.$$

It follows from these two inequalities that

$$\begin{aligned} \inf\{d(x', B) \mid x' \in A\} &\leq \inf\{d(x, y) \mid x \in A, y \in B\} \\ &= d(A, B) \leq \inf\{d(x, B) \mid x \in A\}, \end{aligned}$$

hence we have equality

$$d(A, B) = \inf\{d(x, B) \mid x \in A\}.$$

2. Now, $\varphi : S \rightarrow \mathbb{R}$, given by $\varphi(x) = d(x, B)$, is continuous, and A is compact. Therefore, $\varphi(x)$ attains its minimum at a point $a_0 \in A$, so

$$\varphi(a_0) = d(a_0, B) = \inf\{d(x, B) \mid x \in A\} = d(A, B).$$

If also B is compact, then use that $\psi(y) = d(a_0, y)$ is continuous, so there exists a $b_0 \in B$, such that

$$d(a_0, b_0) = \inf\{d(a_0, y) \mid y \in B\} = \inf\{d(x, y) \mid x \in A, y \in B\} = d(A, B).$$

3. It follows from $K \subseteq U$ that $K \cap (S \setminus U) = \emptyset$. The mapping

$$\varphi(x) = d(x, S \setminus U)$$

is continuous, and since K is compact, we can by (2) find a point $x_0 \in K$, such that

$$d(K, S \setminus U) = d(x_0, S \setminus U) > 0,$$

because $x_0 \notin S \setminus U$. (Strictly speaking we shall choose $R > 0$, such that $B = (S \setminus U) \cup \overline{B_R(x_0)} \neq \emptyset$, thus B is closed and bounded, etc.)

Then choose $r \in]0, d(K, S \setminus U)[$, and we have

$$B_r(x) \cup S \setminus U = \emptyset \quad \text{for all } x \in K,$$

hence

$$B_r(x) \subseteq U \quad \text{for all } x \in K.$$

Example 7.3 Let $E = C^\infty([0, 2\pi], \mathbb{R})$ be the vector space of differentiable functions $f : [0, 2\pi] \rightarrow \mathbb{R}$ of class C^∞ . For $f \in E$ we set

$$\|f\|_0 = \sup\{|f(x)| \mid x \in [0, 2\pi]\},$$

$$\|f\|_1 = \sup\{|f(x)| + |f'(x)| \mid x \in [0, 2\pi]\}.$$

1. Show that $\|\cdot\|_0$ and $\|\cdot\|_1$ are norms in E .

Define the linear mapping $D : E \rightarrow E$ by associating to $f \in E$ the derivative $f' \in E$ of f , i.e.

$$D(f) = f' \quad \text{for } f \in E.$$

2. Show that for every $n \in \mathbb{N}$ there exists a function $f_n \in E$ for which $\|f_n\|_0 = 0$ and $\|D(f_n)\|_0 = n$. Utilize this to show that $D : E \rightarrow E$ is not continuous, when E is equipped with the norm $\|\cdot\|_0$.
3. Show that $D : E_1 \rightarrow E_0$ is continuous, when E_1 is E equipped with the norm $\|\cdot\|_1$ and E_0 is E equipped with the norm $\|\cdot\|_0$.

1. Obviously, $\|f\|_0 \geq 0$, and if

$$\|f\|_0 = \sup\{|f(x)| \mid x \in [0, 2\pi]\} = 0,$$

then $f(x) = 0$ for every $x \in [0, 2\pi]$, thus $f = 0$.

Furthermore,

$$\|\alpha f\|_0 = \sup\{|\alpha f(x)| \mid x \in [0, 2\pi]\} = |\alpha| \sup\{|f(x)| \mid x \in [0, 2\pi]\} = |\alpha| \|f\|_0.$$

Finally, we get concerning the triangle inequality

$$\begin{aligned} \|f + g\|_0 &= \sup\{|f(x) + g(x)| \mid x \in [0, 2\pi]\} \leq \sup\{|f(x)| + |g(x)| \mid x \in [0, 2\pi]\} \\ &\leq \sup\{|f(x)| \mid x \in [0, 2\pi]\} + \sup\{|g(x)| \mid x \in [0, 2\pi]\} = \|f\|_0 + \|g\|_0. \end{aligned}$$

Summing up we have proved that $\|\cdot\|_0$ is a norm.

Then $\|f\|_1 \geq \|f\|_0 \geq 0$. If

$$\|f\|_1 = \sup\{|f(x)| + |f'(x)| \mid x \in [0, 2\pi]\} = 0,$$

then

$$|f(x)| + |f'(x)| = 0 \quad \text{for every } x \in [0, 2\pi].$$

This implies that $|f(x)| = 0$ for every $x \in [0, 2\pi]$, i.e. $f = 0$.

Furthermore,

$$\|\alpha f\|_1 = \sup\{|\alpha f(x)| + |\alpha f'(x)| \mid x \in [0, 2\pi]\} = |\alpha| \sup\{|f(x)| + |f'(x)| \mid x \in [0, 2\pi]\} = |\alpha| \|f\|_1.$$

Finally,

$$\begin{aligned} \|f + g\|_1 &= \sup\{|f(x) + g(x)| + |f'(x) + g'(x)| \mid x \in [0, 2\pi]\} \\ &\leq \sup\{|f(x)| + |f'(x)| \mid x \in [0, 2\pi]\} + \sup\{|g(x)| + |g'(x)| \mid x \in [0, 2\pi]\} = \|f\|_1 + \|g\|_1. \end{aligned}$$

We conclude that $\|\cdot\|_1$ is also a norm.

2. The form of the interval $[0, 2\pi]$ indicates that we shall think of trigonometric examples. Choosing

$$f_n(x) = \sin nx, \quad x \in [0, 2\pi],$$

it follows that $f_n \in E$ and

$$f'_n(x) = n \cdot \cos nx, \quad x \in [0, 2\pi],$$

thus

$$\|f_n\|_0 = \sup\{|\sin nx| \mid x \in [0, 2\pi]\} = 1,$$

and

$$\|D(f_n)\|_0 = \sup\{n|\cos nx| \mid x \in [0, 2\pi]\} = n.$$

Clearly, the sequence $g_n = \frac{1}{n} f_n$ converges towards 0, because

$$\|g_n\|_0 = \frac{1}{n} \rightarrow 0 \quad \text{for } n \rightarrow \infty.$$

The image sequence $\|D(g_n)\|_0 = \frac{1}{n} \cdot n = 1$ does *not* converge towards 0, and $D : E_0 \rightarrow E_0$ is not continuous.

3. The claim follows from the estimate

$$\begin{aligned} \|D(f)\|_0 &= \sup\{|f'(x)| \mid x \in [0, 2\pi]\} \\ &\leq \sup\{|f(x)| + |f'(x)| \mid x \in [0, 2\pi]\} = \|f\|_1. \end{aligned}$$

The mapping D is linear, so it suffices to prove the continuity at 0:

To any given $\varepsilon > 0$ we choose $\delta = \varepsilon > 0$. If $\|f\|_1 < \delta = \varepsilon$, then $\|D(f)\|_0 \leq \|f\|_1 < \varepsilon$, and we have proved that $D : E_1 \rightarrow E_0$ is continuous.

Remark 7.1 The example shows that the same mapping $D : E \rightarrow E$ can be continuous in one topology and discontinuous in another one. Both norms $\|\cdot\|_0$ and $\|\cdot\|_1$ are classically known. \diamond

Please click the advert







www.1calendar.dk

8 Addition and multiplication by scalars in normed vector spaces

Example 8.1 Let V be the space of continuous functions $f : \mathbb{R} \rightarrow \mathbb{R}$, such that $f(x) \rightarrow 0$ for $|x| \rightarrow \infty$. For a function $f \in V$ holds, in other words

$$\forall \varepsilon > 0 \exists a \in \mathbb{R}^+ \forall x \in \mathbb{R} : |x| > a \implies |f(x)| < \varepsilon.$$

Define the operations ‘addition’ and ‘multiplication with scalars’ in V by the obvious pointwise definitions.

1. Show that V is a vector space.
2. Show that every function $f \in V$ is bounded.

Making use of (2), we can define

$$\|f\| = \sup\{|f(x)| \mid x \in \mathbb{R}\} \quad \text{for } f \in V.$$

3. Show that $\|\cdot\|$ is a norm in V .

1. If $f, g \in V$ and $\alpha \in \mathbb{R}$, then $f + \alpha \cdot g : \mathbb{R} \rightarrow \mathbb{R}$ is continuous, and

$$f(x) + \alpha \cdot g(x) \rightarrow 0 + \alpha \cdot 0 = 0 \quad \text{for } |x| \rightarrow \infty,$$

so $f + \alpha \cdot g \in V$, and V is a vector space.

2. Let $f \in V$, and choose e.g. $\varepsilon = 1$. There exists an $a > 0$, such that $|f(x)| < 1$, whenever $|x| > a$. The residual set $[-a, a]$ is a compact interval. The function f is continuous, so $|f|$ has a maximum A on $[-a, a]$. Then

$$\|f\| = \sup\{|f(x)| \mid x \in \mathbb{R}\} \leq \max\{1, A\} < \infty,$$

and we have proved that f is bounded.

3. It follows from (2) that $\|f\| < \infty$ for every $f \in V$. The rest is well-known: $\|f\| \geq 0$, and if

$$\|f\| = \sup\{|f(x)| \mid x \in \mathbb{R}\} = 0,$$

then $f(x) = 0$ for every $x \in \mathbb{R}$, hence $f = 0$.

Furthermore,

$$\|\alpha \cdot f\| = \sup\{|\alpha f(x)| \mid x \in \mathbb{R}\} = |\alpha| \sup\{|f(x)| \mid x \in \mathbb{R}\} = |\alpha| \cdot \|f\|,$$

and

$$\begin{aligned} \|f + g\| &= \sup\{|f(x) + g(x)| \mid x \in \mathbb{R}\} \leq \sup\{|f(x)| + |g(x)| \mid x \in \mathbb{R}\} \\ &\leq \sup\{|f(x)| \mid x \in \mathbb{R}\} + \sup\{|g(x)| \mid x \in \mathbb{R}\} = \|f\| + \|g\|. \end{aligned}$$

Example 8.2 Let V be the space of sequences

$$x = (\alpha_1, \alpha_2, \dots, \alpha_i, \dots)$$

of real numbers $\alpha_i \in \mathbb{R}$ in which at most finitely many $\alpha_i \neq 0$.

Define the operations 'addition' and 'multiplication with scalars' in V by the obvious coordinate-wise definitions. Furthermore, set

$$\|x\| = \sum_{i=1}^{\infty} |\alpha_i|.$$

1. Show that V is a vector space and that $\|\cdot\|$ is a norm in V .
2. Consider an infinite series of real numbers

$$\sum_{i=1}^{\infty} a_i.$$

(There is no condition that at most finitely many $a_i \neq 0$.)

Define the sequence (x_n) in V by $x_1 = (a_1, 0, 0, \dots)$, $x_2 = (a_1, a_2, 0, \dots)$, and in general

$$x_n = (a_1, a_2, \dots, a_n, 0, \dots).$$

Show that the series $\sum_{i=1}^{\infty} |a_i|$ is convergent, if and only if the sequence (x_n) is a Cauchy sequence (fundamental sequence) in the normed vector space V , i.e.

$$\forall \varepsilon > 0 \exists n_0 \in \mathbb{N} \forall n, k \in \mathbb{N} : n \geq n_0 \implies \|x_{n+k} - x_n\| < \varepsilon.$$

3. Give an example of a Cauchy sequence in the normed vector space V that has no limit point in V .

1. Let $x = (\alpha_1, \alpha_2, \dots, \alpha_i, \dots) \in V$ and $y = (\beta_1, \beta_2, \dots, \beta_i, \dots) \in V$, and $k \in \mathbb{R}$. Then

$$x + ky = (\alpha_1 + k\beta_1, \alpha_2 + k\beta_2, \dots, \alpha_i + k\beta_i, \dots),$$

and since $x, y \in V$, there exists an N , such that $\alpha_i = \beta_i = 0$ for every $i > N$. Then also $\alpha_i + k\beta_i = 0$ for every $i > N$, hence $x + ky \in V$, and V is a vector space.

It is obvious that $\|x\| \geq 0$, and if $\|x\| = \sum_{i=1}^{\infty} |\alpha_i| = 0$, then all $\alpha_i = 0$, thus $x = 0$. Furthermore,

$$\|kx\| = \sum_{i=1}^{\infty} |k\alpha_i| = |k| \sum_{i=1}^{\infty} |\alpha_i| = |k| \cdot \|x\|,$$

and

$$\|x + y\| = \sum_{i=1}^{\infty} |\alpha_i + \beta_i| \leq \sum_{i=1}^{\infty} |\alpha_i| + \sum_{i=1}^{\infty} |\beta_i| = \|x\| + \|y\|.$$

We have proved that $\|\cdot\|$ is a norm.

2. Assume that $\sum_{i=1}^{\infty} |a_i| < \infty$ is convergent. This means that

$$\forall \varepsilon > 0 \exists N : \sum_{i=N}^{\infty} |a_i| < \varepsilon.$$

Then for every $n \geq N$ and every $k \in \mathbb{N}$,

$$\|x_{n+k} - x_n\| = \sum_{i=n+1}^{n+k} |a_i| \leq \sum_{i=N}^{\infty} |a_i| < \varepsilon,$$

and (x_n) is a Cauchy sequence.

Conversely, if (x_n) is a Cauchy sequence,

$$\forall \varepsilon > 0 \exists n_0 \in \mathbb{N} \forall n, k \in \mathbb{N} : n \geq n_0 \implies \|x_{n+k} - x_n\| < \varepsilon,$$

then for $n = n_0$ and every $k \in \mathbb{N}$,

$$\sum_{i=n_0+1}^{n_0+k} |a_i| < \varepsilon, \quad \text{thus} \quad \lim_{k \rightarrow \infty} \sum_{i=n_0+1}^{n_0+k} |a_i| \leq \varepsilon,$$

or

$$\sum_{i=n_0+1}^{\infty} |a_i| \leq \varepsilon.$$

Please click the advert

**Design your
own future at
MAN Diesel**

www.mandiesel.com

MAN Diesel – Powering the World



Download free books at BookBooN.com

We conclude that

$$\left| \sum_{i=1}^{\infty} |a_i| - \sum_{i=1}^{n_0} |a_i| \right| = \sum_{i=n_0+1}^{\infty} |a_i| \leq \varepsilon,$$

thus $\sum_{i=1}^{\infty} |a_i| < \infty$, and

$$\sum_{i=1}^{\infty} |a_i| = \sum_{k \in \mathbb{N}} \sum_{i=1}^k |a_i| \quad \text{is uniquely determined.}$$

3. Choose $a_i = \frac{1}{i^2}$. Then

$$\sum_{i=1}^{\infty} \frac{1}{i^2} = \frac{\pi^2}{6}$$

is convergent, and (x_n) is a Cauchy sequence in V .

The limit point is

$$\left(1, \frac{1}{4}, \frac{1}{9}, \dots, \frac{1}{i^2}, \dots \right) \notin V,$$

because every coordinate is > 0 .

Example 8.3 Let V be a finite dimensional, normed vector space with norm $\|\cdot\|$. Let $L : V \rightarrow V$ be an arbitrary linear mapping. Show that there exists a unit vector $x_0 \in V$, i.e. $\|x_0\| = 1$, such that $\|L(x_0)\| = \|L\|$, where $\|L\|$ is the operator norm of L , i.e.

$$\|L\| = \sup\{\|L(x)\| \mid \|x\| = 1\}.$$

Show by an example that this does not hold in general, when V has infinite dimension.

Any finite dimensional and normed vector space V is isomorphic with $(\mathbb{R}^n, \|\cdot\|^*)$ for some n and some norm $\|\cdot\|^*$. In particular, the closed unit ball in V is compact.

Since $L : V \rightarrow V$ is continuous, there exists a point x_0 from the compact set $\{x \in V \mid \|x\| = 1\}$, such that $\|x_0\| = 1$, and such that

$$\|L\| = \sup\{\|L(x)\| \mid \|x\| = 1\} = \|L(x_0)\|.$$

Then let V be the infinite dimensional vector space with consists of all summable sequences (x_n) of the norm

$$\|(x_n)\|_1 = \sum_{n=1}^{\infty} |x_n|,$$

and let $L : V \rightarrow V$ denote the linear mapping which is degenerated by

$$L(e_n) = \left(1 - \frac{1}{n}\right) e_n, \quad n \in \mathbb{N}.$$

Clearly, $\|L\| \leq 1$, and we conclude from

$$\lim_{n \rightarrow \infty} \|L(e_n)\|_1 = \lim_{n \rightarrow \infty} \left(1 - \frac{1}{n}\right) = 1,$$

that $\|L\| = 1$.

Finally, if $\|(x_n)\|_1 = \sum_{n=1}^{\infty} |x_n| = 1$ is any unit vector, then there exists an $n_0 \in \mathbb{N}$, such that $|x_{n_0}| \neq 0$. Then we have for every unit vector (x_n) , $\|(x_n)\|_1 = 1$ that

$$\|L((x_n))\|_1 = \sum_{n=1}^{\infty} \left(1 - \frac{1}{n}\right) |x_n| < \sum_{n=1}^{\infty} |x_n| = 1,$$

and $\|L((x_n))\|_1 < 1$ for every unit vector (x_n) , so the claim does not hold in general for infinitely dimensional spaces.

9 Normed vector spaces and integral operators

Example 9.1 Let $C([0, 1], \mathbb{R})$ be the vector space of continuous real-valued functions in the unit interval $[0, 1]$. For a continuous function $f : [0, 1] \rightarrow \mathbb{R}$ we set

$$\|f\|_1 = \int_0^1 |f(x)| dx.$$

1. Show that $\|\cdot\|_1$ is a norm in $C([0, 1], \mathbb{R})$.

We now equip $C([0, 1], \mathbb{R})$ as a normed vector space with the norm $\|\cdot\|_1$ and define the function

$$I : C([0, 1], \mathbb{R}) \rightarrow \mathbb{R} \quad \text{by} \quad I(f) = \int_0^1 f(x) dx.$$

2. Show that I is a continuous linear function.

3. Determine the operator norm of I .

4. In $C([0, 1], \mathbb{R})$ equipped with the norm $\|\cdot\|_1$, consider the sequences (f_n) and (g_n) defined by

$$f_n(x) = \begin{cases} 1 - nx & \text{for } 0 \leq x \leq \frac{1}{n}, \\ 0 & \text{for } \frac{1}{n} \leq x \leq 1, \end{cases}$$

$$g_n(x) = \begin{cases} n - n^2x & \text{for } 0 \leq x \leq \frac{1}{n}, \\ 0 & \text{for } \frac{1}{n} \leq x \leq 1. \end{cases}$$

Examine the convergence of each of these sequences and, in case of convergence, determine the limit function.

1. Obviously, $\|f\|_1 \geq 0$. It follows from f being continuous and

$$\|f\|_1 = \int_0^1 |f(x)| dx = 0,$$

that $|f(x)| = 0$ for every x , so $f = 0$.

Remark 9.1 We give a simple indirect proof. Assume that $|f(x_0)| > 0$ for some $x_0 \in [0, 1]$. Then there are a constant $c > 0$ and an interval J with $x_0 \in J$ of length $\varepsilon > 0$, such that $|f(x)| \geq c$ for every $x \in J$. Then we have the estimate

$$\|f\|_1 = \int_0^1 |f(x)| dx \geq \int_J |f(x)| dx \geq c \cdot \varepsilon > 0,$$

and the claim follows. This proof should be well-known to the reader, so it is only given here for completeness in a remark. \diamond

Furthermore,

$$\|\alpha \cdot f\|_1 = \int_0^1 |\alpha \cdot f(x)| dx = |\alpha| \int_0^1 |f(x)| dx = |\alpha| \cdot \|f\|_1,$$

and

$$\|f + g\|_1 = \int_0^1 |f(x) + g(x)| dx \leq \int_0^1 |f(x)| dx + \int_0^1 |g(x)| dx = \|f\|_1 + \|g\|_1,$$

and we have proved that $\|\cdot\|_1$ is a norm.

2. It follows from

$$|I(f)| = \left| \int_0^1 f(x) dx \right| \leq \int_0^1 |f(x)| dx = \|f\|_1,$$

that I is continuous.

(To any $\varepsilon > 0$ choose $\delta = \varepsilon$, such that if $\|f\|_1 < \delta = \varepsilon$, then $|I(f)| \leq \|f\|_1 < \varepsilon$).

3. It follows from the estimate in (2) that

$$\|I\| = \sup\{|I(f)| \mid \|f\|_1 = 1\} \leq \sup\{\|f\|_1 \mid \|f\|_1 = 1\} = 1,$$

thus $\|I\| \leq 1$.

On the other hand, if $f(x) \geq 0$, then

$$|I(f)| = \int_0^1 f(x) dx = \|f\|_1,$$

and $\|I\| \geq 1$.

We conclude that $\|I\| = 1$.

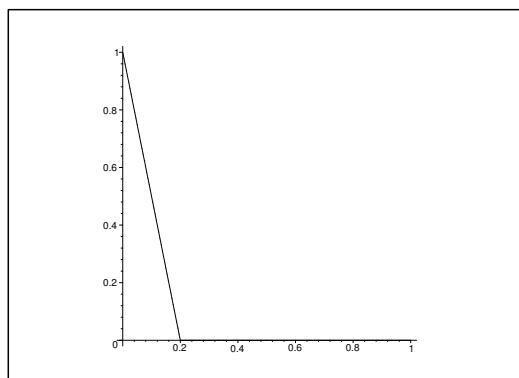

Figure 16: The graph of $f_5(x)$.

4. A simple figure shows that both (f_n) and (g_n) converge pointwise towards 0 for $x \in]0, 1]$, so 0 is the only candidate of a limit value. We infer from

$$\|f_n - 0\|_1 = \|f_n\| = \frac{1}{2} \cdot 1 \cdot \frac{1}{n} = \frac{1}{2n} \rightarrow 0 \quad \text{for } n \rightarrow \infty,$$

that $f_n \rightarrow 0$ for $n \rightarrow \infty$ in the norm $\|\cdot\|_1$.

This goes wrong for (g_n) :

$$\|g_n - 0\|_1 = \|g_n\| = \frac{1}{2} \cdot n \cdot \frac{1}{n} = \frac{1}{2},$$

which does not converge towards the only possible limit value 0 for $n \rightarrow \infty$, and (g_n) is not convergent.

Example 9.2 Let $f : E \rightarrow F$ be a mapping between normed vector spaces E and F which is differentiable at $0 \in E$ and has the property $f(\alpha h) = \alpha f(h)$ for all $\alpha \in \mathbb{R}$ and all $h \in E$. Show that f is linear.

When f is differentiable at $0 \in E$, then there exists a linear mapping $Df(0) : E \rightarrow F$, such that

$$f(x) - f(0) = Df(0)x + \varepsilon(x)\|x\|_E \quad \text{for alle } x \in E,$$

where we have used that $f(0) = f(0 \cdot 0) = 0 \cdot f(0) = 0$.

Insert $\alpha(x + y)$ instead of x . Then

$$\begin{aligned}\alpha f(x + y) &= f(\alpha x + \alpha y) = Df(0)(\alpha x + \alpha y) + \varepsilon(\alpha(x + y))\|\alpha(x + y)\|_E \\ &= \alpha Df(0)x + \alpha Df(0)y + \varepsilon(\alpha(x + y)) \cdot |\alpha| \|x + y\|_E.\end{aligned}$$

When this identity is divided by $\alpha \neq 0$, we get with another ε -function,

$$f(x + y) = Df(0)x + Df(0)y + \varepsilon(\alpha(x + y)) \cdot \|x + y\|_E.$$

It follows by taking the limit $\alpha \rightarrow 0$ that

$$f(x + y) = Df(0)x + Df(0)y.$$

An analogous, though simpler argument shows that

$$f(x) = Df(0)x \quad \text{and} \quad f(y) = Df(0)y,$$

thus

$$f(x + y) = Df(0)x + Df(0)y = f(x) + f(y).$$

Please click the advert

The advertisement features a light blue background with a central sequence of four icons connected by plus signs and an equals sign. The first icon is a black shopping cart labeled 'Student Discounts'. The second is a blue calendar labeled 'Student Events' with the year '2009' on it. The third is a grey square with a black pound symbol (£) labeled 'Money Saving Advice'. The fourth is a yellow square with three white stars labeled 'Happy Days!'. Below this sequence, the text 'wealthystudent.co.uk' is displayed in a bold, sans-serif font, with 'wealthy' in dark grey and 'student.co.uk' in light blue.

Finally,

$$f(x + \lambda y) = f(x) + f(\lambda y) = f(x) + \lambda f(y).$$

This holds for every $x, y \in E$ and every $\lambda \in \mathbb{R}$, so we have proved that f is linear.

Example 9.3 Let $C([0, 1], \mathbb{R})$ be the vector space of continuous functions $f : [0, 1] \rightarrow \mathbb{R}$ equipped as a normed vector space with the norm

$$\|f\| = \sup\{|f(x)| \mid 0 \leq x \leq 1\}.$$

Let $\Phi = \Phi(x, y) : [0, 1] \times [0, 1] \rightarrow \mathbb{R}$ be a continuous function in two variables defined in the square $[0, 1] \times [0, 1]$ in \mathbb{R}^2 . Assume that $\Phi(x, y) \geq 0$ for all $(x, y) \in [0, 1] \times [0, 1]$.

Define the function $\varphi = \varphi(x) : [0, 1] \rightarrow \mathbb{R}$ by

$$\varphi(x) = \sup\{\Phi(x, y) \mid 0 \leq y \leq 1\}.$$

For $f \in C([0, 1], \mathbb{R})$ we define the function $f_\Phi = f_\Phi(y) : [0, 1] \rightarrow \mathbb{R}$ by

$$f_\Phi(y) = \int_0^1 \Phi(x, y) f(x) dx.$$

1. Show that for every $\varepsilon > 0$ there exists a $\delta > 0$ such that

(a) $\Phi(x_0, y) - \varepsilon \leq \Phi(x, y) \leq \Phi(x_0, y) + \varepsilon$ for $|x - x_0| \leq \delta$ and all $y \in [0, 1]$.

(b) $|\Phi(x, y) - \Phi(x, y_0)| \leq \varepsilon$ for $|y - y_0| \leq \delta$ and all $x \in [0, 1]$.

Make use of this to show that the functions $\varphi = \varphi(x)$ and $f_\Phi = f_\Phi(y)$ are continuous.

Since $f_\Phi \in C([0, 1] \times \mathbb{R})$, we can define the mapping

$$L : C([0, 1], \mathbb{R}) \rightarrow C([0, 1], \mathbb{R}) \quad \text{by} \quad L(f) = f_\Phi.$$

The mapping L is called an integral operator with kernel Φ .

2. Show that L is a continuous linear mapping.

3. Show that

$$\|L(f)\| \leq \left(\int_0^1 \varphi(x) dx \right) \|f\|$$

for all $f \in C([0, 1], \mathbb{R})$.

4. Show that the operator norm for L is given by

$$\|L\| = \sup \left\{ \int_0^1 \Phi(x, y) dx \mid 0 \leq y \leq 1 \right\}.$$

1. The mapping Φ is continuous on the compact set $[0, 1] \times [0, 1]$, hence Φ is uniformly continuous, thus to every $\varepsilon > 0$ there exists a $\delta > 0$, such that if (x_0, y_0) and $(x, y) \in [0, 1] \times [0, 1]$ satisfy the conditions

$$|x - x_0| < \delta \quad \text{and} \quad |y - y_0| < \delta,$$

then

$$|\Phi(x_0, y_0) - \Phi(x, y)| < \varepsilon.$$

If in particular, $y = y_0$, then of course $|y - y_0| = 0 < \delta$, and it follows that

$$\text{if } |x - x_0| < \delta, \text{ then } |\Phi(x_0, y) - \Phi(x, y)| < \varepsilon,$$

which is also written

$$\Phi(x_0, y) - \varepsilon \leq \Phi(x, y) \leq \Phi(x_0, y) + \varepsilon \quad \text{for } |x - x_0| \leq \delta, y \in [0, 1].$$

When we repeat the argument with $|y - y_0| < \delta$ and $x = x_0 \in [0, 1]$, we get

$$|\Phi(x, y) - \Phi(x, y_0)| \leq \varepsilon \quad \text{for } |y - y_0| \leq \delta \text{ and } x \in [0, 1].$$

It follows from the estimates

$$\Phi(x_0, y) - \varepsilon \leq \Phi(x, y) \leq \Phi(x_0, y) + \varepsilon$$

for $|x - x_0| \leq \delta$ and $y \in [0, 1]$ that

$$\begin{aligned} \sup\{\Phi(x_0, y) \mid y \in [0, 1]\} - \varepsilon &\leq \sup\{\Phi(x, y) \mid y \in [0, 1]\} \\ &\leq \sup\{\Phi(x_0, y) \mid y \in [0, 1]\} + \varepsilon, \end{aligned}$$

and then we use the definition of φ to imply that

$$\varphi(x_0) - \varepsilon \leq \varphi(x) \leq \varphi(x_0) + \varepsilon,$$

thus $|\varphi(x) - \varphi(x_0)| < \varepsilon$, which holds whenever $|x - x_0| < \delta$. This proves that φ is continuous.

If $|y - y_0| < \delta$, then we get the estimates

$$\begin{aligned} |f_{\Phi}(y) - f_{\Phi}(y_0)| &= \left| \int_0^1 \{\Phi(x, y) - \Phi(x, y_0)\} f(x) dx \right| \\ &\leq \int_0^1 |\Phi(x, y) - \Phi(x, y_0)| \cdot |f(x)| dx \\ &\leq \varepsilon \int_0^1 |f(x)| dx = \|f\|_1 \cdot \varepsilon. \end{aligned}$$

This implies that $f_{\Phi} : [0, 1] \rightarrow \mathbb{R}$ is continuous.

2. Clearly,

$$\begin{aligned} L(f + \lambda g) &= \int_0^1 \Phi(x, y) \{f(x) + \lambda g(x)\} dx \\ &= \int_0^1 \Phi(x, y) f(x) dx + \lambda \int_0^1 \Phi(x, y) g(x) dx \\ &= L(f)(y) + \lambda L(g)(y), \end{aligned}$$

hence $L(f + \lambda g) = L(f) + \lambda L(g)$, and the mapping L is linear.

Furthermore, $|\Phi(x, y)|$ has a maximum, $\|\Phi\|_{\infty}$ på $[0, 1] \times [0, 1]$,

$$\|\Phi\|_{\infty} = \sup\{|\Phi(x, y)| \mid (x, y) \in [0, 1] \times [0, 1]\},$$

because Φ is continuous on the compact set $[0, 1] \times [0, 1]$. Then

$$\begin{aligned} \|L(f)\| &= \sup\{|L(f)(y)| \mid 0 \leq y \leq 1\} = \sup \left\{ \left| \int_0^1 \Phi(x, y) f(x) dx \right| \mid 0 \leq y \leq 1 \right\} \\ &\leq \sup \left\{ \int_0^1 |\Phi(x, y)| \cdot |f(x)| dx \mid 0 \leq y \leq 1 \right\} \\ &\leq \sup \left\{ \int_0^1 \|\Phi\|_{\infty} \cdot \|f\| dx \mid 0 \leq y \leq 1 \right\} = \|\Phi\|_{\infty} \cdot \|f\|. \end{aligned}$$

If $\Phi = 0$, then $L(f) = 0$ which is trivially continuous.

If $\Phi \neq 0$, then $\|\Phi\|_{\infty} > 0$. Choose to $\varepsilon > 0$, the δ by

$$\delta = \frac{\varepsilon}{\|\Phi\|_{\infty}}.$$

If $\|f\| < \delta$, then $\|L(f)\| < \varepsilon$, proving that L is continuous at 0. Since L is linear and continuous at 0, it is continuous everywhere.

3. In this case we use the estimate above in the following way:

$$\begin{aligned}\|L(f)\| &\leq \sup \left\{ \int_0^1 |\Phi(x, y)| \cdot |f(x)| dx \mid 0 \leq y \leq 1 \right\} \leq \int_0^1 \sup\{|\Phi(x, y)| \mid 0 \leq y \leq 1\} \cdot \|f\| dx \\ &= \left(\int_0^1 \varphi(x) dx \right) \|f\|.\end{aligned}$$

4. From $\Phi(x, y) \geq 0$, and

$$\begin{aligned}\|L(1)\| &= \sup \left\{ \int_0^1 \Phi(x, y) dx \mid 0 \leq y \leq 1 \right\} \leq \|L\| \\ &= \sup_{\|f\|=1} \sup \left\{ \int_0^1 \Phi(x, y) f(x) dx \mid 0 \leq y \leq 1 \right\} \\ &\leq \sup \left\{ \int_0^1 \Phi(x, y) dx \mid 0 \leq y \leq 1 \right\},\end{aligned}$$

(because $|f(x)| \leq 1$), follows that

$$\|L\| = \sup \left\{ \int_0^1 \Phi(x, y) dx \mid 0 \leq y \leq 1 \right\}.$$

Please click the advert

WHAT'S MISSING IN THIS EQUATION?

You could be one of our future talents

MAERSK INTERNATIONAL TECHNOLOGY & SCIENCE PROGRAMME

Are you about to graduate as an **engineer** or **geoscientist**? Or have you already graduated?
If so, there may be an exciting future for you with A.P. Moller - Maersk.



MAERSK

www.maersk.com/mitas

10 Differentiable mappings

Example 10.1 Let U be an open set in a normed vector space E . A real-valued function $f : U \rightarrow \mathbb{R}$ is said to have a local maximum (minimum) at a point $x_0 \in U$ if there exists a neighbourhood $N \subseteq U$ of x_0 such that $f(x) \leq f(x_0)$ [$f(x) \geq f(x_0)$] for all $x \in N$.

1. Suppose that the function $f : U \rightarrow \mathbb{R}$ is differentiable at the point $x_0 \in U$. Prove that for each fixed $h \in E$, there exists an $r > 0$ such that the function $g(t) = f(x_0 + th)$ is defined for $t \in]-r, r[$ and is differentiable at 0 with derivative $g'(0) = Df(x_0)(h)$.
2. Suppose that the function $f : U \rightarrow \mathbb{R}$ is differentiable at the point $x_0 \in U$ and that f has the local maximum (minimum) at $x_0 \in U$. Prove that the differential of f at x_0 is zero, i.e. $Df(x_0) = 0$.

1. When $f : U \rightarrow \mathbb{R}$ is differentiable at $x_0 \in U$, then

$$f(x_0 + h) - f(x_0) = Df(x_0)(h) + \varepsilon(h)\|h\|,$$

hence

$$g(t) = f(x_0 + th) = f(x_0) + t \cdot Df(x_0)(h) + \varepsilon(th) \cdot t\|h\|.$$

Then $g(0) = f(x_0)$, and

$$g(t) - g(0) = t \cdot Df(x_0)(h) + t \cdot \varepsilon(th)\|h\|,$$

hence

$$\lim_{t \rightarrow 0} \frac{g(t) - g(0)}{t - 0} = Df(x_0)(h) + \lim_{t \rightarrow 0} \varepsilon(th) \cdot \|h\| = Df(x_0)(h),$$

i.e. $g'(0) = Df(x_0)(h)$.

2. Assume e.g. that $f(x) \leq f(x_0)$ for every $x \in N$. (Analogously, if $f(x) \geq f(x_0)$). Then

$$0 \geq f(x_0 + h) - f(x_0) = Df(x_0)(h) + \varepsilon(h)\|h\|,$$

hence

$$\lim_{h \rightarrow 0} Df(x_0) \left(\frac{h}{\|h\|} \right) \leq 0$$

and

$$\lim_{h \rightarrow 0} Df(x_0) \left(-\frac{h}{\|h\|} \right) = -\lim_{h \rightarrow 0} Df(x_0) \left(\frac{h}{\|h\|} \right) \leq 0,$$

so

$$\lim_{h \rightarrow 0} Df(x_0) \left(\frac{h}{\|h\|} \right) = 0.$$

We get that $Df(x_0) = 0$, because $h/\|h\|$ is an arbitrary unit vector.

Example 10.2 Let \mathcal{H} denote a vector space with inner product $\langle \cdot, \cdot \rangle$ and associated norm $\|\cdot\|$ defined by $\|x\| = \sqrt{\langle x, x \rangle}$ for $x \in \mathcal{H}$. (Example: $\mathcal{H} = \mathbb{R}^n$ equipped with the standard inner product $\langle x, y \rangle = \sum_{i=1}^n x_i y_i$.) Let E denote a finite dimensional proper subspace of \mathcal{H} and let $u \in \mathcal{H}$ be a fixed point in \mathcal{H} outside E .

Define the function $f : E \rightarrow \mathbb{R}$ by

$$f(x) = \|x - u\|^2 = \langle x - u, x - u \rangle \quad \text{for } x \in E.$$

1. Prove that f is differentiable at every point $x \in E$ with differential $Df(x) : E \rightarrow \mathbb{R}$ given by

$$Df(x)(h) = 2\langle x - u, h \rangle \quad \text{for all } h \in E.$$

2. Prove that the differential of f is zero at exactly one point $x_0 \in E$.

HINT: The differential of f is zero at $x_0 \in E$, i.e. $Df(x_0) = 0$, if and only if the vector $x_0 - u$ is orthogonal to E .

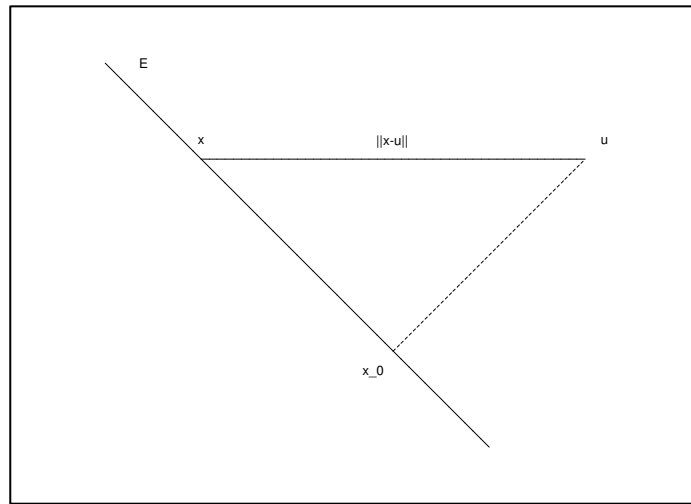

1. We shall only rearrange a little for $x, h \in E$,

$$\begin{aligned} f(x+h) - f(x) &= \langle x+h-u, x+h-u \rangle - \langle x-u, x-u \rangle \\ &= \langle (x-u)+h, (x-u)+h \rangle - \langle x-u, x-u \rangle \\ &= \{\langle x-u, x-u \rangle + 2\langle x-u, h \rangle + \langle h, h \rangle\} - \langle x-u, x-u \rangle \\ &= 2\langle x-u, h \rangle + \|h\|^2, \end{aligned}$$

hence

$$Df(x)(h) = 2\langle x-u, h \rangle \quad \text{og} \quad \|h\|^2 = \varepsilon(h) \cdot \|h\|, \quad \text{med} \quad \varepsilon(h) = \|h\|,$$

and the claim is proved.

2. Let $x_0 \in E$ be the point of the minimum for $f(x) = d(x, u)^2$. It exists, because $E \cap \overline{B}_R(u)$ is compact for $R > \text{dist}(E, u)$, and $f(x), x \in E$, is continuous. It follows from EXAMPLE 10.1 that $Df(x_0) = 0$, so $x_0 - u$ is perpendicular to E .

Any other $x \in E$ can be written $x = x_0 + h, h \in E$. From $h \perp x_0 - u$, and Pythagoras's theorem follow that

$$\|x - u\|^2 = \|x_0 - u\|^2 + \|h\|^2,$$

and

$$2\langle x - u, k \rangle = 2\langle x_0 - u + h, k \rangle = 2\langle h, k \rangle, \quad k \in E, \quad h \in E.$$

Choosing $k = h \neq 0$ we see that the differential is $\neq 0$ at $x = x_0 + h$, $h \in E \setminus \{0\}$, and the claim is proved.

Example 10.3 Let \mathbb{R}^n denote the n -dimensional Euclidean space equipped with the usual inner product

$$\langle x, y \rangle = \sum_{i=1}^n x_i y_i,$$

and the associated norm

$$\|x\| = \sqrt{\langle x, x \rangle} = \sqrt{\sum_{i=1}^n x_i x_i}.$$

Denote by $E = C^1([a, b], \mathbb{R}^n)$ the space of differentiable real-valued functions $f : [a, b] \rightarrow \mathbb{R}^n$ of class C^1 defined on the interval $[a, b]$ in \mathbb{R} . We can equip E with the structure of a normed vector space with norm

$$\|f\|_1 = \sup_{a \leq t \leq b} (\|f(t)\| + \|f'(t)\|).$$

Define the (kinetic) energy function $K : E \rightarrow \mathbb{R}$ by

$$K(f) = \frac{1}{2} \int_a^b \|f'(t)\|^2 dt = \frac{1}{2} \int_a^b \langle f'(t), f'(t) \rangle dt \quad \text{for } f \in E.$$

1. Prove that K is differentiable at every $f \in E$ with differential $DK(f) : E \rightarrow \mathbb{R}$ given by

$$DK(f)(h) = \int_a^b \langle f'(t), h'(t) \rangle dt \quad \text{for all } h \in E.$$

2. Prove that the differential of K at $f \in E$ is zero, i.e. $DK(f) = 0$, if and only if f is a constant function. HINT: (Try to set $h = f$.)

3. Provide a physical interpretation of the result in (2).

1. By a computation,

$$\begin{aligned} & K(f+h) - K(f) \\ &= \frac{1}{2} \int_a^b \langle f'(t) + h'(t), f'(t) + h'(t) \rangle dt - \frac{1}{2} \int_a^b \langle f'(t), f'(t) \rangle dt \\ &= \frac{1}{2} \int_a^b \{ \langle f'(t), f'(t) \rangle + 2\langle f'(t), h'(t) \rangle + \langle h'(t), h'(t) \rangle - \langle f'(t), f'(t) \rangle \} dt \\ &= \int_a^b \langle f'(t), h'(t) \rangle dt + \frac{1}{2} \int_a^b \|h'(t)\|^2 dt, \end{aligned}$$

where

$$\frac{1}{2} \int_a^b \|h'(t)\|^2 dt \leq \frac{1}{2} (b-a) \cdot \|h\|_1^2 = \frac{1}{2} (b-a) \|h\|_1 \cdot \|h\|_1,$$

thus

$$0 \leq \varepsilon(h) \leq \frac{1}{2} (b-a) \|h\|_1 \rightarrow 0 \quad \text{for } \|h\|_1 \rightarrow 0.$$

The first term is linear in h for fixed f , thus

$$DK(f)(h) = \int_a^b \langle f'(t), h'(t) \rangle dt \quad \text{for every } f \in E, \quad h \in E.$$

2. If f is constant, then clearly $f'(t) = 0$, hence

$$DK(f)(h) = \int_a^b \langle 0, h'(t) \rangle dt = 0 \quad \text{for alle } h \in E,$$

så $DK(f) = 0$.

If f is not constant, then $f' \neq 0$. Choosing $h = f$ we get

$$DK(f)(f) = \int_a^b \langle f'(t), f'(t) \rangle dt = \int_a^b \|f'(t)\|^2 dt > 0,$$

which shows that $DK(f) \neq 0$, and the claim is proved.

3. Let $f(t)$ denote the space coordinate of a particle, which moves along the X -axis. The velocity is $f'(t)$, and the kinetic energy is

$$K(f) = \frac{1}{2} \int_a^b \|f'(t)\|^2 dt.$$

According to (2) the differential is $DK(f) = 0$, if and only if $f(t)$ is constant, i.e. if and only if the particle is at rest.

Please click the advert

CHALLENGE YOURSELF

WWW.STUDYINSWEDEN.SE

Si.
Swedish Institute

Today's job market values ambitious, innovative, perceptive team players. Swedish universities foster these qualities through a forward-thinking culture where you're close to the latest ideas and global trends.

Whatever your career goals may be, studying in Sweden will give you valuable skills and a competitive advantage for your future. www.studyinsweden.se

11 Complete metric spaces

Example 11.1 Let (S, d) be a metric space. Show that if a subset A in S is a complete metric space in the induced metric from S , then A is a closed set in S .

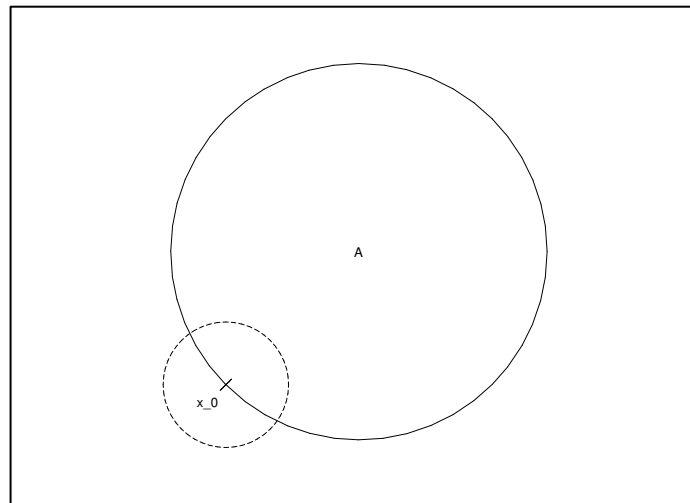

Indirect proof. Let $x_0 \in \overline{A} \setminus A$, i.e.

$$A \cap B_r(x_0) \neq \emptyset \quad \text{for every } r > 0.$$

To a given $r = \frac{1}{n}$ we choose $x_n \in A \cap B_{1/n}(x_0)$. Then $x_n \rightarrow x_0$ in S for $n \rightarrow \infty$. A convergent sequence is also a Cauchy sequence, thus (x_n) is a Cauchy sequence in both S and A .

In a metric space a possible limit point for a Cauchy sequence is always unique. The limit point is $x_0 \notin A$, and we have constructed a Cauchy sequence on A , which is not convergent in A . Hence, A is not complete in the induced topology.

We get by contraposition that if A is complete in the induced topology, then A is closed.

Example 11.2 Let X be a compact topological space, and let S be a complete metric space with metric d .

By $C(X, S)$ we denote the space of continuous mappings $f : X \rightarrow S$.

For $f, g \in C(X, S)$ we put

$$D(f, g) = \sup_{x \in X} d(f(x), g(x)).$$

Then D is a metric in $C(X, S)$.

1. Show that (f_n) is a Cauchy sequence in the metric space $(C(X, S), D)$ if and only if $(f_n : X \rightarrow S)$ is a uniform Cauchy sequence, i.e.

$$\forall \varepsilon > 0 \exists n_0 \in \mathbb{N} \forall n, m \in \mathbb{N} : n, m \geq n_0 \implies \forall x \in X : d(f_n(x), f_m(x)) < \varepsilon.$$

Now let (f_n) be a Cauchy sequence in $(C(X, S), D)$.

2. Show that for every $x \in X$, there exists a uniquely determined $y \in S$, such that $f_n(x) \rightarrow y$ for $n \rightarrow \infty$.

Define a mapping $f : X \rightarrow S$ by setting $f(x) = y$ for all $x \in X$, where $y \in S$ is determined as in (2). In other words, the mapping f is defined by

$$f(x) = \lim_{n \rightarrow \infty} f_n(x) \quad \text{for } x \in X.$$

3. First show that (f_n) converges uniformly to f for n going to ∞ , i.e.

$$\forall \varepsilon > 0 \exists n_0 \in \mathbb{N} \forall n \in \mathbb{N} : n \geq n_0 \implies \forall x \in X : d(f_n(x), f(x)) < \varepsilon.$$

Next show that $f : X \rightarrow S$ is continuous.

HINT:

$$d(f(x), f(x_0)) \leq d(f(x), f_n(x)) + d(f_n(x), f_n(x_0)) + d(f_n(x_0), f(x_0)).$$

4. Show that $(C(X, S), D)$ is a complete metric space.

1. Since d is a metric, it follows that

$$D(f, g) = \sup_{x \in X} d(f(x), g(x)) \geq 0.$$

Furthermore, since X is compact, we have $D(f, g) < \infty$, so D is defined.

If $D(f, g) = 0$, then $d(f(x), g(x)) = 0$ for every $x \in X$, thus $f = g$.

Furthermore,

$$D(f, g) = \sup_{x \in X} d(f(x), g(x)) = \sup_{x \in X} d(g(x), f(x)) = D(g, f),$$

and

$$\begin{aligned} D(f, g) &= \sup_{x \in X} d(f(x), g(x)) \\ &\leq \sup_{x \in X} \{d(f(x), h(x)) + d(h(x), g(x))\} \\ &\leq \sup_{x \in X} d(f(x), h(x)) + \sup_{x \in X} d(h(x), g(x)) \\ &= D(f, h) + D(h, g), \end{aligned}$$

and we have proved that D is a metric on $C(X, S)$.

Assume that (f_n) is a Cauchy sequence in $(C(X, S), D)$. Then

$$(3) \quad \forall \varepsilon > 0 \exists n_0 \in \mathbb{N} \forall m, n \geq n_0 : D(f_m, f_n) < \varepsilon.$$

Now,

$$D(f_m, f_n) = \sup_{x \in X} d(f_m(x), f_n(x)) \geq d(f_m(x), f_n(x))$$

for all $x \in X$, so

$$(4) \quad \forall \varepsilon > 0 \exists n_0 \in \mathbb{N} \forall m, n \geq n_0 \forall x \in X : d(f_m(x), f_n(x)) < \varepsilon.$$

We see that this is the condition that (f_n) is a uniform Cauchy sequence.

Conversely, if (f_n) is a uniform Cauchy sequence, then (4) holds, and thus in particular

$$d(f_m(x), f_n(x)) < \varepsilon \quad \text{for alle } x \in X,$$

and it follows that

$$D(f_m, f_n) = \sup_{x \in X} d(f_m(x), f_n(x)) \leq \varepsilon.$$

The only difference from the above is that we here have “ $\leq \varepsilon$ ” instead of “ $< \varepsilon$ ”, so we derive again (3). This means that (f_n) is a Cauchy sequence in $(C(X, S), D)$, and (1) is proved.

Please click the advert

www.job.oticon.dk

oticon
PEOPLE FIRST

2. Then let (f_n) be a Cauchy sequence in $(C(X, S), D)$. It follows from (1) that (f_n) is a uniform Cauchy sequence. In particular, $(f_n(x))$ is a Cauchy sequence on S for every $x \in X$. Since S is complete, $(f_n(x))$ is convergent for every $x \in X$, hence

$$\forall x \in X \exists y \in S : \lim_{n \rightarrow \infty} f_n(x) = y.$$

Now, y corresponds uniquely to x , so

$$f(x) = \lim_{n \rightarrow \infty} f_n(x), \quad x \in X,$$

is a well-defined mapping.

3. The sequence (f_n) is a uniform Cauchy sequence, and the pointwise limit function f exists everywhere. Hence, (f_n) is uniformly convergent with the limit function f .

We shall prove that the limit function f is continuous. Using the hint we consider the estimate

$$(5) \quad d(f(x), f(x_0)) \leq d(f(x), f_n(x)) + d(f_n(x), f_n(x_0)) + d(f_n(x_0), f(x_0)).$$

It follows from (4) that given any $\varepsilon > 0$ we can find an n_0 , such that

$$d(f_m(x), f_n(x)) < \frac{\varepsilon}{6} \quad \text{for every } x \in X, \text{ if } m, n \geq n_0.$$

It follows that

$$d(f(x), f_n(x)) < \frac{\varepsilon}{6} + \frac{\varepsilon}{6} = \frac{\varepsilon}{3} \quad \text{for every } x \in X \text{ and } n \geq n_0,$$

and we now control the first and the third term of (5).

Using that $f_n(x)$ is uniformly continuous there is a $\delta > 0$, such that

$$d(f_n(x), f_n(x_0)) < \frac{\varepsilon}{3}, \quad \text{if } x \in U_\varepsilon(x_0),$$

where $U_\varepsilon(x_0)$ is an open neighbourhood corresponding to ε and x_0 .

Hence, if $x \in U_\varepsilon(x_0)$, then

$$d(f(x), f(x_0)) \leq \frac{\varepsilon}{3} + \frac{\varepsilon}{3} + \frac{\varepsilon}{3} = \varepsilon,$$

and f is continuous at every $x_0 \in X$, i.e. in all of X .

4. We shall only collect all the previous results: If (f_n) is a Cauchy sequence in $(C(X, S), D)$, then $(f_n), f_n : X \rightarrow S$, is a uniform Cauchy sequence of limit function f , where this limit function $f \in C(X, S)$ is also continuous.

In other words: The Cauchy sequence (f_n) converges uniformly (hence also in the metric D) towards a continuous function $f \in C(X, S)$, and $(C(X, S), D)$ is a complete space.

12 Local Existence and Uniqueness Theorem for Autonomous Ordinary Differential Equations

Example 12.1 (*Local Existence and Uniqueness Theorem for Autonomous Ordinary Differential Equations.*)

Let E be a Banach space, and let $U \subseteq E$ be an open set in E . The norm in E is denoted by $\|\cdot\|$.

A mapping $f : U \rightarrow E$ is said to be Lipschitz continuous in U , if there exists a constant k , such that

$$\|f(x_1) - f(x_2)\| \leq k\|x_1 - x_2\| \quad \text{for all } x_1, x_2 \in U.$$

Now assume that $f : U \rightarrow E$ is a Lipschitz continuous mapping in U . (One can think of f as a vector field in U by placing the vector $f(x) \in E$ at every point $x \in U$.)

Consider the Initial Value Problem consisting of the differential equation (i) below together with the initial value condition (ii):

$$(i) \quad \frac{dx}{dt} = f(x), \quad (ii) \quad x(0) = x_0 \in U.$$

By a solution, or, an integral curve, to the Initial Value Problem (i) and (ii) we understand a differential curve $\varphi : J \rightarrow U$ defined in an interval J around $0 \in \mathbb{R}$, such that

$$\frac{d\varphi}{dt} = f(\varphi(t)) \quad \text{for all } t \in J,$$

and such that $\varphi(0) = x_0$.

1. Show that $\varphi : J \rightarrow U$ solves (i) and (ii) if and only if φ satisfies the integral equation

$$\varphi(t) = x_0 + \int_0^t f(\varphi(\tau)) d\tau.$$

For $a > 0$, let J_a denote the interval $J_a = [-a, a]$, and for $b > 0$, let

$$S_b = \{x \in E \mid \|x - x_0\| \leq b\}$$

denote the closed ball in E with centre $x_0 \in U$ and radius b . For $b > 0$ sufficiently small, we have $S_b \subseteq U$, and we shall only consider such b .

Let $C(J_a, S_b)$ denote the space of continuous mappings $\varphi : J_a \rightarrow S_b$ equipped with the metric D as in EXAMPLE 11.2.

To $\varphi \in C(J_a, S_b)$ we associate $\psi : J_a \rightarrow E$ defined by

$$\psi(t) = x_0 + \int_0^t f(\varphi(\tau)) d\tau \quad \text{for } t \in J_a.$$

2. Show that for sufficiently small $a > 0$, the mapping $\psi \in C(J_a, S_b)$.

3. Show that for sufficiently small $a > 0$, the mapping

$$T : C(J_a, S_b) \rightarrow C(J_a, S_b),$$

which assigns $\psi = T(\varphi) \in C(J_a, S_b)$ to $\varphi \in C(J_a, S_b)$, is a contraction.

4. Show that with $a > 0$ as in (3), there exists a unique solution $\varphi \in C(J_a, S_b)$ to the differential equation

$$\frac{dx}{dt} = f(x),$$

such that $\varphi(0) = x_0$.

5. Show that if $\varphi_1 : J_1 \rightarrow U$ and $\varphi_2 : J_2 \rightarrow U$ are two solutions to the differential equation

$$\frac{dx}{dt} = f(x),$$

defined in overlapping open intervals J_1 and J_2 in \mathbb{R} , such that $\varphi_1(t_0) = \varphi_2(t_0)$ at a point $t_0 \in J_1 \cap J_2$, then $\varphi_1(t) = \varphi_2(t)$ at all points $t \in J_1 \cap J_2$.

6. Show that there exists a unique maximal solution to the Initial Value Problem (i) and (ii). (A maximal solution in a solution with an open interval of definition that cannot be extended.)

1. It follows from $\frac{d\varphi}{dt} = f(\varphi(t))$ by an integration that

$$[\varphi(\tau)]_0^t = \varphi(t) - \varphi(0) = \int_0^t f(\varphi(\tau)) d\tau,$$

so we get since $\varphi(0) = x_0$ that

$$\varphi(t) = x_0 + \int_0^t f(\varphi(\tau)) d\tau.$$

Conversely, if φ is given by this integral equation, then $\varphi(0) = x_0 + 0 = x_0$, and

$$\frac{d\varphi}{dt} = [f(\varphi(\tau))]_{\tau=t} = f(\varphi(t)),$$

and the claim is proved.

Please click the advert

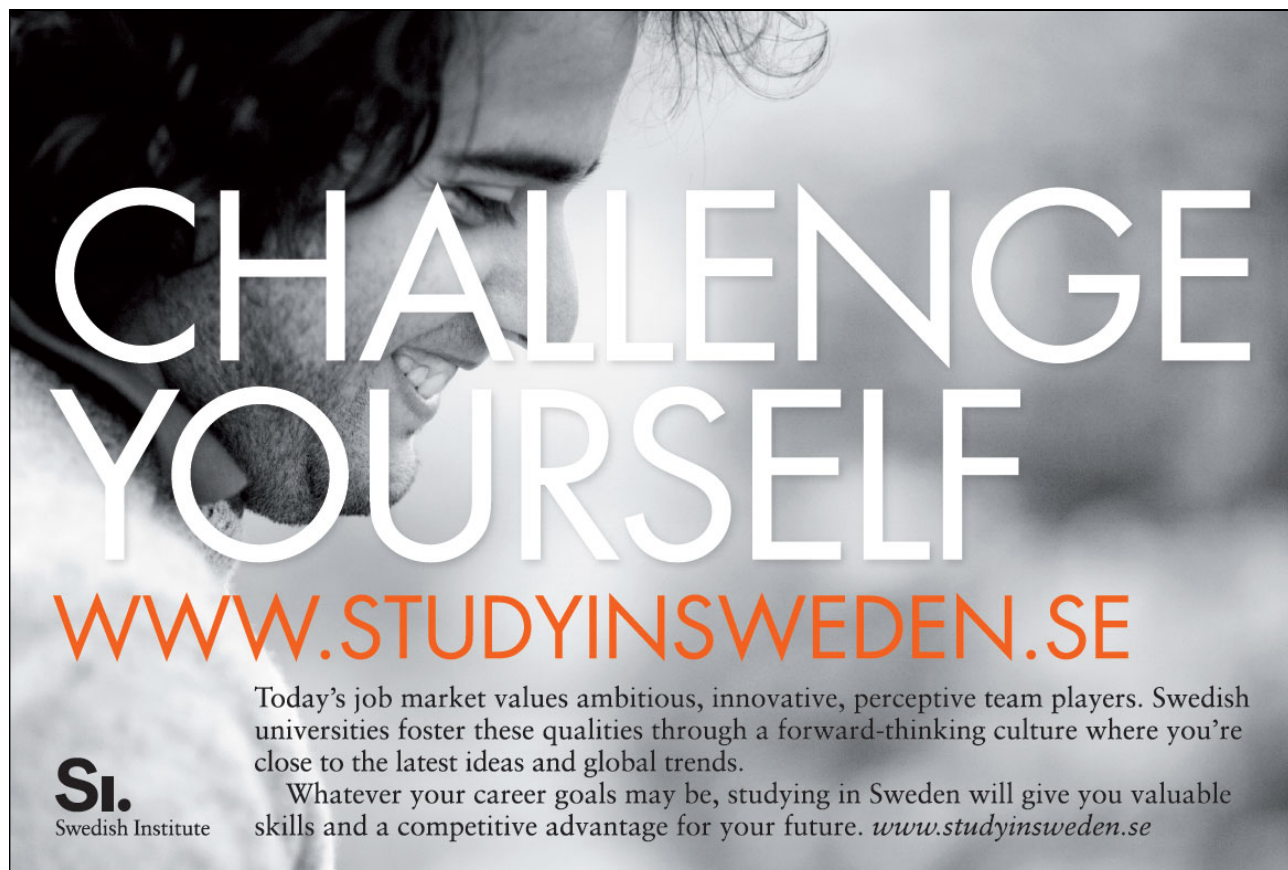

CHALLENGE YOURSELF

WWW.STUDYINSWEDEN.SE

Today's job market values ambitious, innovative, perceptive team players. Swedish universities foster these qualities through a forward-thinking culture where you're close to the latest ideas and global trends.

Whatever your career goals may be, studying in Sweden will give you valuable skills and a competitive advantage for your future. www.studyinsweden.se

Si.
Swedish Institute

2. From $S_b \subseteq U$ follows that $\varphi(t) \in U$ for every $t \in J_a$, hence

$$\begin{aligned}\psi(t) - \psi(t_0) &= \left\{ x_0 + \int_0^t f(\varphi(\tau)) d\tau \right\} - \left\{ x_0 + \int_0^{t_0} f(\varphi(\tau)) d\tau \right\} \\ &= \int_{t_0}^t f(\varphi(\tau)) d\tau = \int_{t_0}^t \{f(\varphi(\tau)) - f(\varphi(t_0))\} d\tau + \int_{t_0}^t f(\varphi(t_0)) d\tau,\end{aligned}$$

and we get the estimate

$$\begin{aligned}\|\psi(t) - \psi(t_0)\| &\leq \left| \int_{t_0}^t \|f(\varphi(\tau)) - f(\varphi(t_0))\| d\tau \right| + \|f(\varphi(t_0))\| \cdot |t - t_0| \\ &\leq k \left| \int_{t_0}^t \|\varphi(\tau) - \varphi(t_0)\| d\tau \right| + \|f(\varphi(t_0))\| \cdot |t - t_0|.\end{aligned}$$

Since $\|f(\varphi(t_0))\|$ is a fixed number, we can choose $\delta_1 > 0$, such that

$$\|f(\varphi(t_0))\| \cdot |t - t_0| < \frac{\varepsilon}{2} \quad \text{for } |t - t_0| < \delta_1.$$

Now, φ is continuous, so to every $\varepsilon_1 > 0$ we can choose $\delta_2 > 0$, such that

$$\|\varphi(\tau) - \varphi(t_0)\| < \varepsilon_1 \quad \text{for } |\tau - t_0| < \delta_2.$$

In this case we have

$$k \left| \int_{t_0}^t \|\varphi(\tau) - \varphi(t_0)\| d\tau \right| \leq k \cdot \varepsilon_1 \cdot \delta_2 < \frac{\varepsilon}{2}$$

for $\varepsilon_1, \delta_2 > 0$ sufficiently small. (It suffices to choose $\varepsilon_1 > 0$, and then $\delta_3 = \min\left\{\delta_2, \frac{\varepsilon}{2k}\right\}$).

Then

$$\|\psi(t) - \psi(t_0)\| \leq \frac{\varepsilon}{2} + \frac{\varepsilon}{2} = \varepsilon$$

for $|t - t_0| < \delta = \min\{\delta_1, \delta_3\}$, thus $\psi \in C(J_a, S_b)$.

3. We have

$$T(\varphi_1)(t) - T(\varphi_2)(t) = \left\{ x_0 + \int_0^t f(\varphi_1(\tau)) d\tau \right\} - \left\{ x_0 + \int_0^t f(\varphi_2(\tau)) d\tau \right\} = \int_0^t \{f(\varphi_1(\tau)) - f(\varphi_2(\tau))\} d\tau,$$

so by the Lipschitz condition,

$$\|T(\varphi_1)(t) - T(\varphi_2)(t)\| \leq \left| \int_0^t \|f(\varphi_1(\tau)) - f(\varphi_2(\tau))\| d\tau \right| \leq k \cdot \left| \int_0^t \|\varphi_1(\tau) - \varphi_2(\tau)\| d\tau \right|.$$

If D_a is the metric on $C(J_a, S_b)$, given by

$$D_a(\varphi_1, \varphi_2) = \sup_{t \in J_a} \|\varphi_1(t) - \varphi_2(t)\|,$$

then it follows that

$$D_a(T(\varphi_1), T(\varphi_2)) \leq k \cdot \left| \int_0^t D_a(\varphi_1, \varphi_2) d\tau \right| \leq k \cdot a \cdot D_a(\varphi_1, \varphi_2).$$

Choose $a > 0$, such that $k \cdot a < 1$. Then $T : C(J_a, S_b) \rightarrow C(J_a, S_b)$ is a contraction.

4. It follows from EXAMPLE 11.2 that $(C(J_a, S_b), D_a)$ is a complete metric space. By Banach's fix-point theorem the contraction T has only one fixpoint, thus there exists a unique $\varphi \in C(J_a, S_b)$, such that $\varphi(t) = T(\varphi)(t)$. This means that

$$\varphi(t) = x_0 + \int_0^t f(\varphi(\tau)) d\tau.$$

This is by (1) equivalent with that $x = \varphi(t)$ is the unique solution of

$$\frac{dx}{dt} = f(x), \quad x(0) = x_0.$$

5. Let $\varphi_1 : J_1 \rightarrow U$ and $\varphi_2 : J_2 \rightarrow U$ be two solutions which agree in a point $t_0 \in J_1 \cap J_2$, where both J_1 and J_2 are closed intervals. We claim that

$$\varphi_1(t) = \varphi_2(t) \quad \text{for every } t \in J_1 \cap J_2.$$

The mapping $\varphi_1 - \varphi_2$ is continuous, so

$$\{t \in J_1 \cap J_2 \mid \varphi_1(t) = \varphi_2(t)\} = (\varphi_1 - \varphi_2)^{\circ-1}(\{0\}) \cap (J_1 \cap J_2)$$

is a closed and nonempty set. If it is not all of $J_1 \cap J_2$, then the set $(\varphi_1 - \varphi_2)^{\circ-1}(\{0\})$ must have a boundary point t_1 , which lies in the interior of $J_1 \cap J_2$.

It follows from $\varphi_1(t_1) = \varphi_2(t_1)$ and the construction above that $\varphi_1(t) = \varphi_2(t)$ in an interval $[t_1 - b, t_1 + b]$ around t_1 , i.e.

$$[t_1 - b, t_1 + b] \subseteq (\varphi_1 - \varphi_2)^{\circ-1}(\{0\}).$$

Then t_1 is not a boundary point which contradicts the assumption. Hence, we conclude that

$$(\varphi_1 - \varphi_2)^{\circ-1}(\{0\}) \cap (J_1 \cap J_2) = J_1 \cap J_2,$$

thus $\varphi_1(t) = \varphi_2(t)$ on $J_1 \cap J_2$.

6. Let $\varphi : J \rightarrow U$ be a maximal solution of (i) and (ii), hence φ is unique on J , and φ cannot be extended further to a unique solution on a larger set $J' \supset J$. We shall prove that the interval J is open.

INDIRECT PROOF. Assume that J is not open, and let $t_0 \in J$ be an end point of the interval. Then there exists a $b > 0$, such that φ is a unique solution in $[t_0 - b, t_0 + b]$. This means that φ is unique on

$$J' = J \cup [t_0 - b, t_0 + b] \supset J,$$

which contains points which are not in J . This is contradicting the assumption, so we conclude that every maximal solution is defined on a maximal open interval.

13 Euler-Lagrange's equations

Example 13.1 Let $[a, b]$ be a closed and bounded interval in \mathbb{R} . Denote by

$$C^1([a, b], \mathbb{R}^n)$$

the vector space of differentiable curves $x : [a, b] \rightarrow \mathbb{R}^n$ in \mathbb{R}^n of class C^1 . Equip $C^1([a, b], \mathbb{R}^n)$ with the norm

$$\|x\|_1 = \sup\{\|x(t)\| + \|x'(t)\| \mid t \in [a, b]\},$$

in which $\|\cdot\|$ is the maximum norm in \mathbb{R}^n .

For an arbitrary open set U in $\mathbb{R} \times \mathbb{R}^n \times \mathbb{R}^n$, we denote by \tilde{U} the subset of curves $x \in C^1([a, b], \mathbb{R}^n)$, in which $(t, x(t), x'(t)) \in U$ for all $t \in [a, b]$.

1. Show that \tilde{U} is an open set in $C^1([a, b], \mathbb{R}^n)$.

Now let U be an open set in $\mathbb{R} \times \mathbb{R}^n \times \mathbb{R}^n$, considered with coordinates

$$(t, q, p) \in \mathbb{R} \times \mathbb{R}^n \times \mathbb{R}^n,$$

and let $L = L(t, q, p) : U \rightarrow \mathbb{R}$ be a differentiable function of class C^1 .

Define the function $f : \tilde{U} \rightarrow \mathbb{R}$ by

$$f(x) = \int_a^b L(t, x(t), x'(t)) dt \quad \text{for } x \in \tilde{U}.$$

2. Show that $f : \tilde{U} \rightarrow \mathbb{R}$ is differentiable in \tilde{U} with the differential determined by

$$Df(x)h = \int_a^b DL(t, x(t), x'(t)) \cdot (0, h(t), h'(t)) dt$$

for $x \in \tilde{U}$ and $h \in C^1([a, b], \mathbb{R}^n)$.

In the following, the curves $x \in \tilde{U}$ and $h \in C^1([a, b], \mathbb{R}^n)$ are kept fixed.

3. Show that there exists an $\varepsilon > 0$, such that the curve $x + \lambda h$ belongs to \tilde{U} , for all $\lambda \in]-\varepsilon, \varepsilon[$.

With reference to (3), define the function $g :]-\varepsilon, \varepsilon[\rightarrow \mathbb{R}$ by

$$g(\lambda) = f(x + \lambda h) \quad \text{for } \lambda \in]-\varepsilon, \varepsilon[.$$

4. Show that g is differentiable at $\lambda = 0$ with the differential quotient

$$\begin{aligned} g'(0) &= \int_a^b DL(t, x(t), x'(t)) \cdot (0, h(t), h'(t)) dt \\ &= \int_a^b \left\{ \sum_{i=1}^n \left(\frac{\partial L}{\partial q_i} h_i + \frac{\partial L}{\partial p_i} h'_i \right) \right\} dt. \end{aligned}$$

Here, as well as in (5), the partial derivatives of L shall be taken at the points $(t, x(t), x'(t)) \in U$ and the functions h_i, h'_i at $t \in [a, b]$.

5. Now assume that $h(a) = h(b) = 0$ and that

$$L = L(t, q, p) : U \rightarrow \mathbb{R}$$

is a differentiable function of class C^2 .

Using integration by parts, first show that

$$\int_a^b \frac{\partial L}{\partial p_i} h'_i dt = - \int_a^b \frac{d}{dt} \left(\frac{\partial L}{\partial p_i} \right) h_i dt,$$

and next that

$$g'(0) = \int_a^b \left\{ \sum_{i=1}^n \left(\frac{\partial L}{\partial q_i} - \frac{d}{dt} \left(\frac{\partial L}{\partial p_i} \right) \right) h_i \right\} dt.$$

The system of equations

$$\frac{\partial L}{\partial q_i} - \frac{d}{dt} \left(\frac{\partial L}{\partial p_i} \right) = 0, \quad i = 1, \dots, n,$$

is called the Euler-Lagrange equations for the above function $f = f(x)$ defined by L . It is of fundamental importance in the calculus of variations.

6. Show that the differentiable curve $x : [a, b] \rightarrow \mathbb{R}^n$ in \tilde{U} is a stationary point of $f : \tilde{U} \rightarrow \mathbb{R}$, i.e. $Df(x) = 0$, if and only if

$$\frac{\partial L}{\partial q_i}(t, x(t), x'(t)) = \frac{d}{dt} \left(\frac{\partial L}{\partial p_i}(t, x(t), x'(t)) \right),$$

for all $i = 1, \dots, n$.

1. Let

$$x_0 \in \tilde{U} = \{x \in C^1([a, b], \mathbb{R}) \mid \forall t \in [a, b] : (t, x(t), x'(t)) \in U\}.$$

Please click the advert

Turning a challenge into a learning curve. Just another day at the office for a high performer.

Accenture Boot Camp – your toughest test yet

Choose Accenture for a career where the variety of opportunities and challenges allows you to make a difference every day. A place where you can develop your potential and grow professionally, working alongside talented colleagues. The only place where you can learn from our unrivalled experience, while helping our global clients achieve high performance. If this is your idea of a typical working day, then Accenture is the place to be.

It all starts at Boot Camp. It's 48 hours that will stimulate your mind and enhance your career prospects. You'll spend time with other students, top Accenture Consultants and special guests. An inspirational two days

packed with intellectual challenges and activities designed to let you discover what it really means to be a high performer in business. We can't tell you everything about Boot Camp, but expect a fast-paced, exhilarating

and intense learning experience. It could be your toughest test yet, which is exactly what will make it your biggest opportunity.

Find out more and apply online.

Visit [accenture.com/bootcamp](https://www.accenture.com/bootcamp)

• Consulting • Technology • Outsourcing

High performance. Delivered.

The mapping $t \mapsto (t, x_0(t), x'_0(t))$ is continuous $[a, b] \rightarrow \mathbb{R}^{2n+1}$, and $[a, b]$ is compact, hence the graph

$$A = \{(t, x_0(t), x'_0(t)) \mid t \in [a, b]\}$$

is compact.

The compact set A and the closed set $\mathbb{R}^{2n+1} \setminus U$ are disjoint, hence

$$\text{dist}(A, \mathbb{R}^{2n+1} \setminus U) > 0.$$

We have for every $\varepsilon \in]0, \text{dist}(A, \mathbb{R}^{2n+1} \setminus U)[$ that

$$\{x \in C^1([a, b], \mathbb{R}^n) \mid \|x - x_0\|_1 < \varepsilon\} \subset \tilde{U}.$$

This is true for every $x_0 \in \tilde{U}$ with $\varepsilon = \varepsilon(x_0) > 0$, so \tilde{U} is open.

2. Let $x \in \tilde{U}$ and $h \in C^1([a, b], \mathbb{R}^n)$ with $x + h \in \tilde{U}$. Then

$$\begin{aligned} Df(x)h &= f(x+h) - f(x) + \varepsilon_1(x, h)\|h\| \\ &= \int_a^b \{L(t, x+h, x'+h') - L(t, x, x')\} dt + \varepsilon_1(x, h)\|h\| \\ &= \int_a^b \{DL(t, x(t), x'(t)) \cdot (0, h(t), h'(t)) + \varepsilon_2(x, h)\|h\|\} dt + \varepsilon_1(x, h)\|h\|. \end{aligned}$$

The interval $[a, b]$ is compact, so

$$\int_a^b \varepsilon_2(x, h)\|h\| dt = \varepsilon_3(x, h)\|h\|,$$

and we get by taking the limit,

$$Df(x)h = \int_a^b DL(t, x(t), x'(t)) \cdot (0, h(t), h'(t)) dt.$$

3. There is nothing to prove for $h = 0$. If $h \neq 0$, choose ε , such that

$$0 < \varepsilon < \frac{1}{\|h\|_1} \text{dist}(A, \mathbb{R}^{2n+1} \setminus U),$$

cf. (1). Then $x + \lambda h \in \tilde{U}$ for every $\lambda \in]-\varepsilon, \varepsilon[$.

4. Now, $g'(\lambda) = Df(x + \lambda h) \cdot h$, so it follows for $\lambda = 0$ from (2) that

$$g'(0) = Df(x) \cdot h = \int_a^b DL(t, x(t), x'(t)) \cdot (0, h(t), h'(t)) dt = \int_a^b \left\{ \sum_{i=1}^n \left(\frac{\partial L}{\partial q_i} h_i + \frac{\partial L}{\partial p_i} h'_i \right) \right\} dt.$$

5. The task is almost described completely in the beginning of the example.

Since $h_i(a) = h_i(b) = 0$, we get by a partial integration that

$$\begin{aligned} \int_a^b \frac{\partial L}{\partial p_i}(t) \cdot h'_i(t) dt &= \left[\frac{\partial L}{\partial p_i}(t) \cdot h_i(t) \right]_a^b - \int_a^b \frac{d}{dt} \left(\frac{\partial L}{\partial p_i} \right) h_i(t) dt \\ &= - \int_a^b \frac{d}{dt} \left(\frac{\partial L}{\partial p_i} \right) \cdot h_i(t) dt. \end{aligned}$$

When this is inserted into (4), it follows that

$$g'(0) = \int_a^b \left\{ \sum_{i=1}^n \left(\frac{\partial L}{\partial q_i} - \frac{d}{dt} \left(\frac{\partial L}{\partial p_i} \right) \right) h_i \right\} dt.$$

6. If $x \in \tilde{U}$ is a stationary point of $f : \tilde{U} \rightarrow \mathbb{R}$, i.e. $Df(x) = 0$, then $g'(0) = 0$ for every $h \in C^1$. Then it follows from (5) that

$$g'(0) = \int_a^b \left\{ \sum_{i=1}^n \left(\frac{\partial L}{\partial q_i} - \frac{d}{dt} \left(\frac{\partial L}{\partial p_i} \right) \right) h_i \right\} dt = 0 \quad \text{for alle } h \in C^1.$$

Choosing in particular

$$h_i = \frac{\partial L}{\partial q_i} - \frac{d}{dt} \left(\frac{\partial L}{\partial p_i} \right), \quad i = 1, \dots, n,$$

we see that this is only possible, if

$$(6) \quad \frac{\partial L}{\partial q_i} - \frac{d}{dt} \left(\frac{\partial L}{\partial p_i} \right) = 0, \quad \text{for } i = 1, \dots, n.$$

Conversely, if (6) holds, then clearly $g'(0) = 0$, and thus $Df(x) = 0$, so x is a stationary point for $f : \tilde{U} \rightarrow \mathbb{R}$.

Please click the advert



it's an **interesting** world

Get under the skin of it.

Graduate opportunities
Cheltenham | £24,945 + benefits

One of the UK's intelligence services, GCHQ's role is two-fold: to gather and analyse intelligence which helps shape Britain's response to global events, and, to provide technical advice for the protection of Government communication and information systems. In doing so, our specialists – in IT, internet, engineering, languages, information assurance, mathematics and intelligence – get well beneath the surface of global affairs. If you thought the world was an interesting place, you really ought to explore our world of work.

www.careersinbritishintelligence.co.uk

Applicants must be British citizens. GCHQ values diversity and welcomes applicants from all sections of the community. We want our workforce to reflect the diversity of our work.



INVESTORS
IN PEOPLE

